



Components occasions

**Alimentatori per
lampade fluorescenti**
*Ballasts for fluorescent
lamps*

Pag. 114

**Alimentatori per
lampade HID**
*Control gears for
HID lamps*

Pag. 118

**Varialuce e dispositivi
di comando**
*Dimmer
and control systems*

Pag. 119

**Apparecchi elettrici
per utilizzo domestico**
*Electrical devices
for domestic use*

Pag. 122

**Trasformatori elettronici
per bassissima tensione**
*Electronic transformers
for extra-low voltage*

Pag. 125

**Apparecchi modulari
per barra DIN**
*Modular system
for DIN track*

Pag. 127











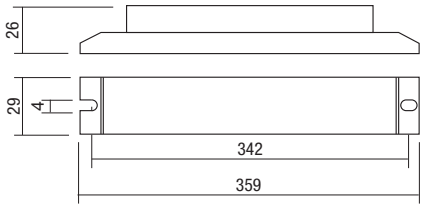

LED Driver









Pag. 128

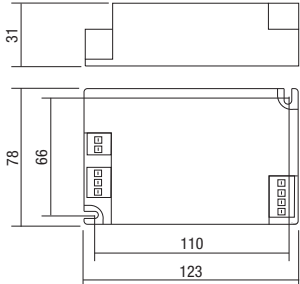







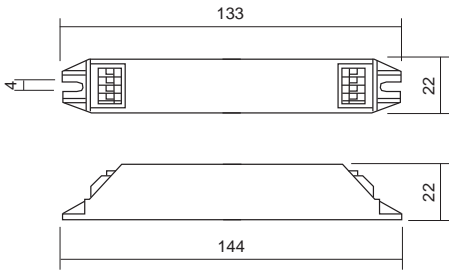

Moduli LED
LED module

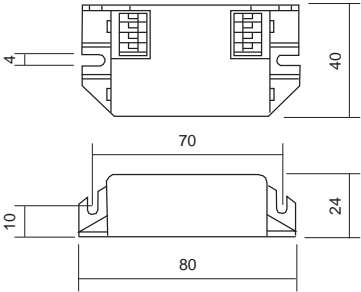

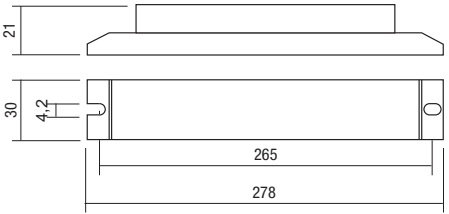
Pag. 132

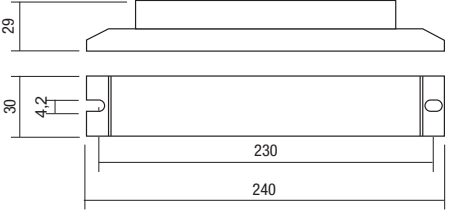
Alimentatori per lampade fluorescenti - *Ballast for fluorescent lamps*

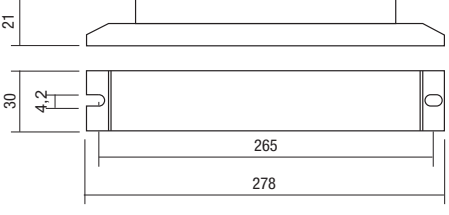



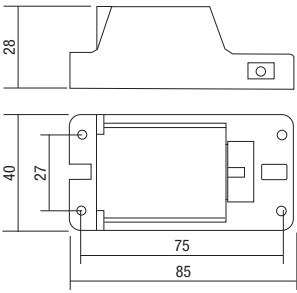

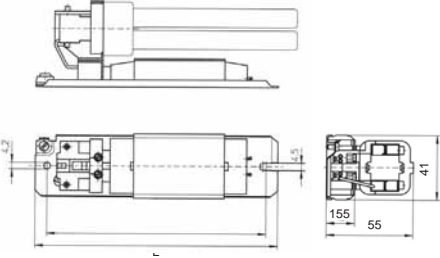

Articolo - Article	Dimensioni - Dimensions (mm)	Cod.	Descrizione - Description	Pack	QTY	Euro
		DL118-40	<p>DIML1840 - 1x 18÷40W - 220-240V - 50/60Hz Ballast elettronico dimmerabile multipower - Interfaccia 1-10V Per lampade lineari e circolari T5 T8 - TC-L - TC-F - FC-T5C <i>Dimmable multipower electronic ballast - 1-10V control signal For linear and circular lamps T5 - T8 TC-L - TC-F - FC-T5C</i></p>  	1	169	10,0
		DL149	<p>DIML49 - 1x 49W - 220-240V - 50/60Hz Ballast elettronico dimmerabile multipower - Interfaccia 1-10V Per lampade lineari e circolari T5 <i>Dimmable multipower electronic ballast - 1-10V control signal For linear and circular lamps T5</i></p>  	1	512	10,0
		DL154-58	<p>DIML5458 - 1x 54÷58W - 220-240V - 50/60Hz Ballast elettronico dimmerabile multipower - Interfaccia 1-10V Per lampade lineari e circolari T5 T8 - TC-L <i>Dimmable multipower electronic ballast - 1-10V control signal For linear and circular lamps T5 T8 - TC-L</i></p>  	1	1.367	10,0
		DL180	<p>DIML80 - 1x 55÷80W - 220-240V - 50/60Hz Ballast elettronico dimmerabile multipower - Interfaccia 1-10V Per lampade lineari e circolari T5 - TC-L <i>Dimmable multipower electronic ballast - 1-10V control signal For linear and circular lamps T5 - TC-L</i></p>  	1	628	10,0
		DL214-35	<p>DIML21435 - 2x 14÷35W - 220-240V - 50/60Hz Ballast elettronico dimmerabile multipower - Interfaccia 1-10V Per lampade lineari T5 <i>Dimmable multipower electronic ballast - 1-10V control signal For linear lamps T5</i></p>  	1	651	10,00
		DL254-58	<p>DIML25458 - 2x 55÷80W - 220-240V - 50/60Hz Ballast elettronico dimmerabile multipower - Interfaccia 1-10V Per lampade lineari e circolari T5 - T8 - TC-L <i>Dimmable multipower electronic ballast - 1-10V control signal For linear and circular lamps T5 - T8 - TC-L</i></p>  	1	80	10,00

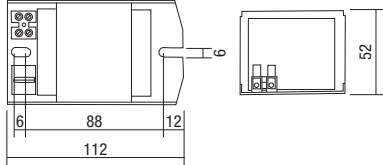
Articolo - Article	Dimensioni - Dimensions (mm)	Cod.	Descrizione - Description	Pack	QTY	Euro
		DS118	<p>DIM118 - 1x 18W - 220-240V - 50/60Hz Ballast elettronico dimmerabile Interfaccia 1-10V Per lampade compatte TC-D/E TC-T/E <i>Dimmable electronic ballast - 1-10V control signal For compact lamps TC-D/E - TC-T/E</i></p> 	1	629	10,00
		DS124-42	<p>DIM2442 - 1x 24÷42W - 220-240V - 50/60Hz Ballast elettronico dimmerabile - Interfaccia 1-10V Per lampade compatte TC-D/E TC-T/E - TC-L - T5C <i>Dimmable electronic ballast - 1-10V control signal - For compact lamps TC-D/E - TC-T/E - TC-L - T5C</i></p>  	1	446	10,00
		DS155	<p>DIM155 - 1x 55W - 220-240V - 50/60Hz Ballast elettronico dimmerabile Interfaccia 1-10V - Per lampade compatte TC-L - T5C <i>Dimmable electronic ballast - 1-10V control signal - For compact lamps TC-L - T5C</i></p> 	1	382	10,00
		DS218	<p>DIM218 - 2x 18W - 220-240V - 50/60Hz Ballast elettronico dimmerabile multipower - Interfaccia 1-10V Per lampade compatte TC-D/E TC-T/E <i>Dimmable multipower electronic ballast - 1-10V control signal For compact lamps TC-D/E - TC-T/E</i></p> 	1	275	10,00
		DS226-42	<p>DIM22642 - 2x 26÷42W - 220-240V - 50/60Hz Ballast elettronico dimmerabile multipower - Interfaccia 1-10V Per lampade compatte TC-D/E TC-T/E - TC-L - FC-T5C <i>Dimmable multipower electronic ballast - 1-10V control signal For compact lamps TC-D/E TC-T/E - TC-L - FC-T5C</i></p>  	1	497	10,00
		DS242	<p>DIM242 - 2x 42W - 220-240V - 50/60Hz Ballast elettronico dimmerabile multipower - Interfaccia 1-10V Per lampade compatte TC-T/E <i>Dimmable multipower electronic ballast - 1-10V control signal For compact lamps TC-T/E</i></p> 	1	150	10,00

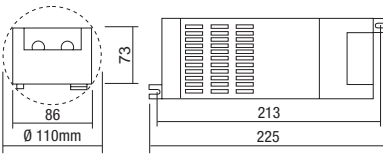
Articolo - Article	Dimensioni - Dimensions (mm)	Cod.	Descrizione - Description	Pack	QTY	Euro
		RN2493 MSL4-8 4÷8W - 220-240V - 50/60Hz Ballast elettronico ad alta efficienza per lampade lineari e compatte di potenza inferiore a 25W <i>High efficiency electronic ballast for linear and compact lamps with wattages less than 25W</i>	10	3.199	2,70	
		RN2494 MSL4-8 9÷16W - 220-240V - 50/60Hz Ballast elettronico ad alta efficienza per lampade lineari e compatte di potenza inferiore a 25W <i>High efficiency electronic ballast for linear and compact lamps with wattages less than 25W</i>	10	1.209	3,00	
		RN2480 MSL14-21 14÷21W - 220-240V - 50/60Hz Ballast elettronico ad alta efficienza per lampade lineari e compatte di potenza inferiore a 25W <i>High efficiency electronic ballast for linear and compact lamps with wattages less than 25W</i>	10	3.437	2,70	
		RN2491 MS4-8 4÷8W - 220-240V - 50/60Hz Ballast elettronico ad alta efficienza per lampade lineari e compatte di potenza inferiore a 25W <i>High efficiency electronic ballast for linear and compact lamps with wattages less than 25W</i>	1	187	2,60	
		RN2250 EB24G5 - 1x 22,5W - 220-240V - 50/60Hz Reattori elettronici (ballast) da incorporare, per lampade fluorescenti T5FH - T5FQ Ø16mm <i>Built-in electronic ballast for T5FH - T5FQ Ø16mm fluorescent lamps</i>	1	7.367	7,00	
		RN2091 EB15G13 - 1x 13,5W - 220-240V - 50/60Hz Reattori elettronici (ballast) da incorporare, per lampade fluorescenti T8 Ø26mm, e compatte <i>Built-in electronic ballast for T8 Ø26mm fluorescent lamps, and compact lamps</i>	1	763	7,00	
		RN2476 MPT5FH214-28 14÷28W - 220-240V - 50/60Hz Reattori elettronici (ballast) da incorporare, per lampade fluorescenti T5FH - T5FQ Ø16mm <i>Built-in electronic ballast for T5FH - T5FQ Ø16mm fluorescent lamps</i>	1	289	7.70	
						

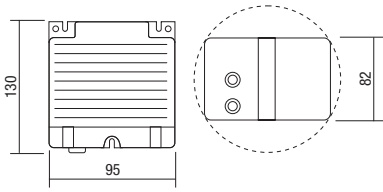
Articolo - Article	Dimensioni - Dimensions (mm)	Cod.	Descrizione - Description	Pack	QTY	Euro
		S53101	<p>FC4 4W - 230V - 50Hz Reattori convenzionali per lampade fluorescenti a catodi preriscaldati <i>Built-in conventional ballast for fluorescent lamps with pre-heated cathodes</i></p>	1	12.514	1,20
		S53505	<p>FP113 10÷13W - 230V - 50Hz Reattori convenzionali da incorporare per lampade fluorescenti compatte, sezione 18x41mm, con attacco diretto <i>Conventional built-in ballast, for compact fluorescent lamp, 18x41mm section, with direct connection</i></p>	10	3.484	2,40

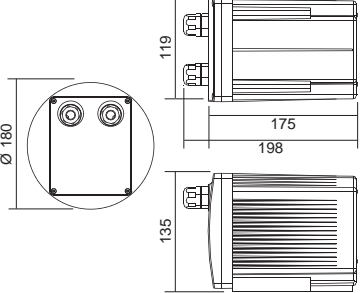
Alimentatori per lampade HID - Control gears for HID lamps

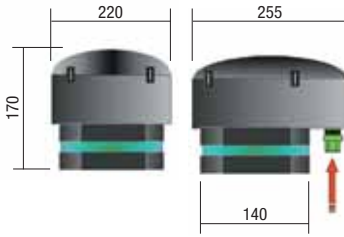
Articolo - Article	Dimensioni - Dimensions (mm)	Cod.	Descrizione - Description	Pack	QTY	Euro
		S52101 B50Q.2 - 50W - 230V - 50Hz Reattori elettromeccanici convenzionali da incorporare - Per lampade a vapori di mercurio (Q) <i>Built-in conventional ballast for mercury vapour lamps (Q)</i>	8	517	5,00	
		S52103 B80Q.2 - 80W - 230V - 50Hz Reattori elettromeccanici convenzionali da incorporare - Per lampade a vapori di mercurio (Q) <i>Built-in conventional ballast For mercury vapour lamps (Q)</i>	8	2.815	5,00	
		S52531 B80Q.2 - 35W - 230V - 50Hz Reattori elettromeccanici convenzionali da incorporare - Per lampade a ioduri metallici (M) <i>Built-in conventional ballast For metal halide lamps (M)</i>	8	12.757	5,80	
		S50311 UR - 35W - 230V - 50Hz Complessi di alimentazione per lampade a scarica in involucro plastico per MONTAGGIO INDIPENDENTE o incasso in classe II (utilizzabili anche in classe I). <i>Power supply system for discharge lamps, with plastic casing to be mounted independently or enclosed, in class II (can be used in class I).</i>	1	900	10,20	
		4M1P035.3 MATRIX - 35W - 230V - 50Hz Contenitore plastico in materiale tecnopolimero autoestinguente. Complesso annegato in resina IP40. <i>Box in technopolymer self-extinguishing plastic material. Resin filled IP40</i>	6	645	10,40	
		S50481 MEGA URC - 35W - 230V - 50Hz Complessi di alimentazione per lampade a scarica <i>Power supply system for discharge lamps</i>	1	133	10,00	
		50035.3 RAIN - 35W - 230V - 50Hz Complesso di alimentazione integrato per lampade a scarica da esterno <i>Built in power supply for outside discharge lamps</i>	1	57	16,70	
		50070.3 RAIN - 70W - 230V - 50Hz Complesso di alimentazione integrato per lampade a scarica da esterno <i>Built in power supply for outside discharge lamps</i>	1	87	18,66	
		50150.3 RAIN - 150W - 230V - 50Hz Complesso di alimentazione integrato per lampade a scarica da esterno <i>Built in power supply for outside discharge lamps</i>	1	173	20,65	

Varialuce e dispositivi di comando - *Dimmer and control system*

Articolo - Article		Cod.	Descrizione - Description	Color	Pack	QTY	Euro
	1 Modul	RM0181	INT34SSL International 20÷500W - 230V - 50Hz Interruttore elettronico con comando a sfioramento <i>Sensorial control electronic switch</i>	Antacite <i>Anthracite</i>	10	572	4,50
	1 Modul	RM0192	INT34SMA Magic 20÷500W - 230V - 50Hz Interruttore elettronico con comando a sfioramento <i>Sensorial control electronic switch</i>	Avorio <i>Ivory</i>	5	896	4,50
	1 Modul	RM0211	INT34STT Magic TT 20÷500W - 230V - 50Hz Interruttore elettronico con comando a sfioramento <i>Sensorial control electronic switch</i>	Avorio <i>Ivory</i>	5	241	4,50
	1 Modul	RM0199	INT34SVI Vimar Idea 20÷500W - 230V - 50Hz Interruttore elettronico con comando a sfioramento <i>Sensorial control electronic switch</i>	Antacite <i>Anthracite</i>	5	426	4,50
	1 Modul	RM0240	RTM34SEK S Eikon Next 40÷500W - 230V - 50Hz Varialuce con comando a sfio- ramento <i>Sensorial control dimmer</i>	Silver	5	113	10,00
	Ø 65	RM0770	RTM65SSL International 40÷500W - 230V - 50Hz Varialuce con comando a sfio- ramento <i>Sensorial control dimmer</i>	Antacite <i>Anthracite</i>	5	135	9,00

Articolo - Article		Cod.	Descrizione - Description	Color	Pack	QTY	Euro
	1 Modul	RP0359	RICEIR34STT Magic TT 230V - 50Hz Modulo ricevitore da incasso senza parte di potenza, da accoppiare obbligatoriamente a un attuatore (varialuce o relè) <i>Recess receiver module without power part, must be coupled to an actuator (dimmer or relay)</i>	Trasparente <i>Transparent</i>	5	127	4,80
	1 Modul	RQ5361/EGY	Magic 40÷900W - 230V - 50Hz Dimmer con comando rotativo <i>Rotary control dimmer</i>	Avorio <i>Ivory</i>	5	1.740	3,50
	1 Modul	RQ9235/EGY	Magic 40÷900W - 230V - 50Hz Dimmer con comando rotativo <i>Rotary control dimmer</i>	Avorio <i>Ivory</i>	5	599	3,50
	1 Modul	RM0203	RIPC134SSL 230V - 50Hz Modulo di estensione per il comando sensoriale di relè monostabili <i>Repeater unit for sensorial control of monostable relay</i>	Silver	5	776	4,50
	1 Modul	RM0213	RIPC134STT 230V - 50Hz Modulo di estensione per il comando sensoriale di relè monostabili <i>Repeater unit for sensorial control of monostable relay</i>	Avorio <i>Ivory</i>	5	484	4,00
	L x P - H (mm) 32x46x20	RQ9544	RT56 75÷300W - 230V - 50Hz Varialuce da inserire in corpi illuminanti - Potenziometro e interruttore incorporato - Per lampade ad incandescenza o alogene <i>Dimmer to insert lamp - Potentiometer and switch incorporated For incandescent or halogen lamps</i>	Nero <i>Black</i>	20	2.185	0,95
		RN0039/UR 	706 40÷160W - 120V - 60Hz Varialuce da inserire in corpi illuminanti - Potenziometro e interruttore incorporato - Per lampade ad incandescenza o alogene <i>Dimmer to insert lamp - Potentiometer and switch incorporated For incandescent or halogen lamps</i>	Nero <i>Black</i>	20	306	1,70

Articolo - Article		Cod.	Descrizione - Description	Color	Pack	QTY	Euro
		RM0905 	RTS80HR British box 60÷400W - 230V - 50/60Hz Varialuce con comando rotativo <i>Rotary control dimmer</i>	Bianco <i>White</i>	20	843	3,30
		RM0908 	RTS280HR British box 2x60÷500W - 230V - 50/60Hz Varialuce con comando rotativo <i>Rotary control dimmer</i>	Bianco <i>White</i>	20	280	6,00
		RM0911 	RTS80HD British box 60÷400W - 230V - 50/60Hz Varialuce con deviatore incorporato <i>Two-way control dimmer</i>	Bianco <i>White</i>	20	205	3,40
		RM0757	RTM65DAK 25÷500W - 230V - 50Hz Varialuce con deviatore incorpora- to <i>Two-way control dimmer</i>	Bianco <i>White</i>	8	1.570	8,00
	L x P - H (mm) 76x95x36	RL0053	CROSS T 40÷500W - 230-240V - 50Hz Varialuce da tavolo con comando sensoriale <i>Table dimmer with sensor control</i>	Bianco <i>White</i>	12	221	4,50
		RL0045		Nero <i>Black</i>	12	76	4,80
		RL0068		Trasparente <i>Transparent</i>	12	637	4,50
		RL0061		Paglierino <i>Straw</i>	12	450	4,50
	L x P - H (mm) 123x38x21	RN1620	MICRO PC 60÷300W - 230V - 50Hz Varialuce elettronico con coman- do a pulsante <i>Electronic dimmer with push- button control</i>	Bianco <i>White</i>	50	1.094	4,00
							
	L x P - H (mm) 32x46x20	RQ0148	RL99P 2÷100W - 220-240V - 50Hz Relè elettronico con comando a pulsante <i>Electronic relay - Push button control</i>	Nero <i>Black</i>	100	3.900	3,80
							

Apparecchi elettrici per utilizzo domestico - *Electrical devices for domestic use*



Articolo - Article	Cod.	Descrizione - Description	Colore Colour	Pack	QTY	Euro
	H5270-10	<p>Avvolgicavo telefonico presa tripolare e una presa modulare plug 6/4c terminale spina 6/4 compreso accessorio spina/presa tripolare e attacco 6/4 Cavo piatto nero lunghezza 10m</p> <p>Telephone cable reel three-pole socket outlet and one modular socket outlet 6/4c terminal plug 6/4 including plug/three pole socket outlet 6/4 Black flat cable - Cable lenght 10m</p>	Arancio Nero Orange Black	Busta cavallotto Euro slot bag	127	2,45
	STV5154/BL	<p>Avvolgicavo TV Lunghezza cavo 10m</p> <p>TV cable reel Cable lenght 10m</p>	Bianco Arancio White Orange	Blister	1.467	3,26
	H6635	<p>Avvolgicavo Avvolgicavo per uso domestico - Tipo chiuso 250V~ 16A - Quattro prese 2P+T multi-standard Italiano e tedesco tipo P17/11 e P30 - Spina 2P+T 16A tipo S17 - Dispositivo di protezione termica - Cavo H05VV-F 3x1,5mm² - Lunghezza cavo 20m</p> <p>Cable reel Cable reel for household and similar purpose type 250V~ 16A - Four 2P+T multi-standard Italian and german sockets P17/11 and P30 type - Plug 2P+T 16A S17 type - Thermal cut out device - Cable H05VV-F 3x1,5mm² - Cable lenght 20m</p>	Arancio Nero Orange Black	Busta cavallotto Euro slot bag	9	18,20
	S80110/BL	<p>Presa sestupla con interruttore luminoso 3 prese bipasso 10/16A + 3 prese 10-16A 1,5 m cavo H05VV-F 3x1 mm² Spina 16A 2P+T 250V~</p> <p>Sextuple socket with luminous switch 3 sockets 3P P17/11 type 10/16A + 3 sockets 10- 16A - 1,5 m cable H05VV-F 3x1 mm² with plug 16A 2P+T 250V~</p>	Bianco White	Blister	641	4,04
	BL/E281/B	<p>Presa sestupla 4 prese 10-16A (tipo italiano 10A, tipo tedesco 16A) + 2 prese 10-16A - 1,5m cavo H05VV-F 3X1 mm² - Spina 16A 2P + T 250V~</p> <p>Sextuple socket 4 sockets 10-16A (Italian type 10A, German type 16A) + 2 sockets 10-16A - 1,5m cable H05VV-F 3X1 mm² - Plug 16A 2P + T 250V ~</p>	Bianco White	Blister	1.427	5,45
	BL/E311/GR	<p>Presa sestupla con interruttore luminoso 6 prese 10-16A (tipo italiano 10A, tipo tedesco 16A) 1,5m cavo H05VV-F 3x1 mm² con spina 16A 2P+T 250V~</p> <p>Sextuple socket with luminous switch 6 sockets 10-16A (Italian type 10A, German type 16A) 1,5 m cable H05VV-F 3x1 mm² with plug 16A 2P+T 250V~</p>	Grigio Grey	Blister	958	4,10



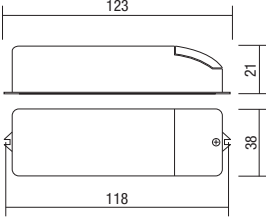

Articolo - Article	Cod.	Descrizione - Description	Colore Colour	Pack	QTY	Euro
	BC/E529/B	<p>Presa compatta con salafulmine 3 x prese 10-16A (tipo italiano 10A, tipo tedesco 16A) + 6x10-16A 1,5 mm cavo H05VV-F 3x1 mm² con spina 16A 2P+T 250V ~</p> <p>Compact socket with surge protection device 3 sockets 10-16A (Italian type 10A, German type 16A) + 6x10-16A 1,5 mm cable H05VV-F 3x1 mm² with plug 16A 2P+T 250V ~</p>	Bianco White	Busta cavallotto Euro slot bag	3.779	4,98
	A-175-C	<p>Presa sestupla 10/16A 2P+T 250V~ Cavo 1,5m H05VV-F 3x1mm² - Spina 16A 2P+T 250V~</p> <p>Sextuple socket 10/16A 2P+T 250V~ 1,5m cable H05VV-F 3x1mm² - With plug 16A 2P+T 250V~</p>	Nero/Blu Black/Blue	Sfuso Loose	440	1,79
	T/E3342/B	<p>Presa quadrupla 10A 2P+T 250V~</p> <p>Quadruple socket 10A 2P+T 250V~</p>	Bianco/Blu White/Blue	Sfuso Loose	450	1,06
	174	<p>Multipresa 4 senza cavo Preso mobile multipla 250V~ 16A Quattro prese 2P+T standard italiano tipo P17/11</p> <p>Multisocket 4 without wire Multiple mobile socket 250V~ 16A Four italian standard sockets 2P+T P17/11 type</p>	Nero Black	Sfuso Loose	1.338	1,06
	176	<p>Multipresa 6 senza cavo Preso mobile multipla 250V~ 16A Sei prese 2P+T standard italiano tipo P17/11</p> <p>Multisocket 6 without wire Multiple mobile socket 250V~ 16A Six italian standard sockets 2P+T P17/11 type</p>	Nero Black	Sfuso Loose	1.493	1,52
	177	<p>Multipresa 7 senza cavo Preso mobile multipla 250V~ 16A Sette prese 2P+T standard italiano tipo P17/11</p> <p>Multisocket 7 without wire Multiple mobile socket 250V~ 16A Seven italian standard sockets 2P+T P17/11 type</p>	Nero Black	Sfuso Loose	241	3,65

Articolo - Article	Cod.	Descrizione - Description	Colore Colour	Pack	QTY	Euro
	BC/E280/B	Presa mobile multipla 250V~ 16A Quattro prese 2P Shuko Max 3000W Multiple mobile socket 250V~ 16A Four 2P sockets Shuko Max 3000W	Bianco White	Sfuso Loose	320	2,59
	BL/EAL160/B	Adattatore multiplo Spina 16A e 3 prese 10/16A 2P+T 250V~ Multiple adapter 16A Plug and 3 sockets 10/16A 2P+T 250V~	Bianco White	Sfuso Loose	688	0,69
	BL/EAT160/N	Adattatore multiplo Spina 16A e 3 prese 10/16A 2P+T 250V~ Multiple adapter 16A Plug and 3 sockets 10/16A 2P+T 250V~	Nero Black	Blister	2.840	0,71
	SEAK160EANG	Adattatore Spina 16A Presa 10-16A (tipo italiano 10A tedesco 16A) 2P+T 250V~ - Potenza massima prelevabile 1500W - Custodia in tecnopolimero - Spinotti ed alveoli attivi protetti da contatto accidentale Adapter 16A Plug 10-16A Socket (Italian 10A German 16A) 2P+T 250V~ - Maximum power that can flow 1500W - Technopolymer Casing - Active pins and pits protected from accidental contact	Giallo Yellow	Sfuso Loose	543	0,60
	S/EAL160/B	Adattatore doppio 10/16A Adattatore doppio - Spia luminosa - 2 prese 2P+T 10/16A - Spina 2P+T 16A Double adapter 10/16A Double adapter - Warning light - 2 sockets 2P+T 10/16A - Plug 2P+T 16A	Bianco White	Sfuso Loose	10.034	0,69
	VL-269-AR	Interruttore automatico mobile 10A 230V 50Hz Una presa 2P+T standard Italiano e Tedesco tipo P30 Una spina 10A 2P +T standard Italiano - Potenza max 2000W protezione differenziale 5mA - Tempo d'intervento minore di 20ms Automatic differential mobile switch 10A 230V 50Hz One socket 2P+T Italian and German standard P30 type - One plug 10A 2P+T Italian standard Max power 2000W differential protection 5mA Intervention time less than 20ms	Arancio Orange	Blister	540	0,65
	VL-269-BL	Interruttore automatico mobile 10A 230V 50Hz Una presa 2P+T standard Italiano e Tedesco tipo P30 Una spina 10A 2P +T standard Italiano - Potenza max 2000W protezione differenziale 5mA - Tempo d'intervento minore di 20ms Automatic differential mobile switch 10A 230V 50Hz One socket 2P+T Italian and German standard P30 type - One plug 10A 2P+T Italian standard Max power 2000W differential protection 5mA Intervention time less than 20ms	Blu Blue	Blister	1.130	0,65

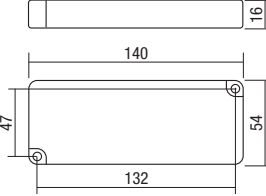
Trasformatori elettronici per bassissima tensione

Electronic transformers for low voltage

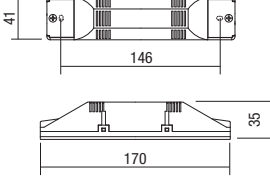

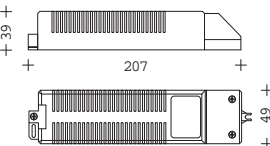





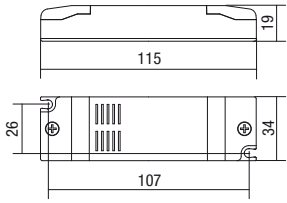

Articolo - Article	Dimensioni - Dimensions (mm)	Cod.	Descrizione - Description	Colore Colour	Pack	QTY	Euro
		PTM70/B 20÷70W - 230V - 50Hz Trasformatori elettronici per lampade alogene a bassissima tensione. Uso Indipendente. <i>Electronic transformers for low voltage halogen lamps for independent use.</i>	Bianco White	10	96	4,80	
		S/PTM/105/B 35÷105W - 230V - 50Hz Trasformatori elettronici per lampade alogene a bassissima tensione. Uso Indipendente. <i>Electronic transformers for low voltage halogen lamps for independent use.</i>	Bianco White	10	68	5,80	
		PTE105/N Max 105W - 230V - 50Hz Trasformatori elettronici per lampade alogene a bassissima tensione. Uso Indipendente. <i>Electronic transformers for low voltage halogen lamps for independent use.</i>	Nero Black	10	100	4,50	
	L x P x H (mm) Ø 88x31	RN1173 BRAVO 110 SPF/HE 35÷110W - 230V - 50/60Hz Trasformatori elettronici per lampade alogene a bassissima tensione. Uso Indipendente. <i>Electronic transformers for low voltage halogen lamps for independent use.</i>	Bianco Arancio White Orange	20	159	4,00	
		S/PTRN/160/B PTRN160 50÷160W - 230-240V - 50/60Hz Trasformatori elettronici per lampade alogene a bassissima tensione. Uso Indipendente. <i>Electronic transformers for low voltage halogen lamps for independent use.</i>	Bianco White	10	22	8,50	
		RN1124 STILO 70 10÷70W - 230V - 50/60Hz Trasformatori elettronici per lampade alogene a bassissima tensione ultrapiatti. Uso Indipendente. <i>Ultra flat electronic transformers for low voltage halogen lamps for independent use.</i>	Bianco White	20	79	4,80	
		RN1128 STILO 105 20÷105W - 230V - 50/60Hz Trasformatori elettronici per lampade alogene a bassissima tensione ultrapiatti. Uso Indipendente. <i>Ultra flat electronic transformers for low voltage halogen lamps for independent use.</i>	Bianco White	20	466	4,80	
		RN1131 STILO 120 20÷120W - 230V - 50/60Hz Trasformatori elettronici per lampade alogene a bassissima tensione ultrapiatti. Uso Indipendente. <i>Ultra flat electronic transformers for low voltage halogen lamps for independent use.</i>	Bianco White	20	404	4,80	

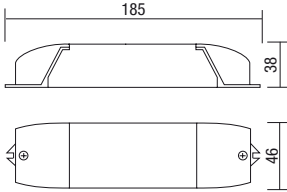

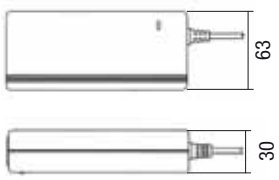

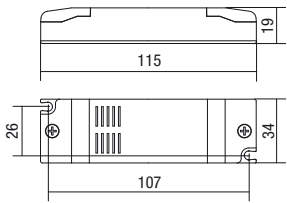

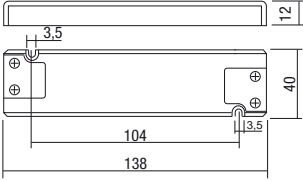

Articolo - Article	Dimensioni - Dimensions (mm)	Cod.	Descrizione - Description	Colore Colour	Pack	QTY	Euro
	<p>L x P x H (mm) 148x38x33</p>	RN1589	<p>SUGAR 150 50÷150W - 230V - 50/60Hz Trasformatori elettronici per lampade alogene a bassissima tensione. Uso Indipendente. <i>Electronic transformers for low voltage halogen lamps for independent use.</i></p>	<p>Bianco Arancio <i>White Orange</i></p>	25	243	5,35
		PTRD/180/B	<p>PTRD180 50÷180W - 230-240V - 50/60Hz Trasformatori elettronici per lampade alogene a bassissima tensione. Uso Indipendente. Dimmerabile <i>Electronic transformers for low voltage halogen lamps for independent use. Dimmable</i></p>	<p>Bianco <i>White</i></p>	10	85	11,00
		PTE/250/B	<p>PTE250 75÷250W - 230-240V - 50/60Hz Trasformatori elettronici per lampade alogene a bassissima tensione. Uso Indipendente. <i>Electronic transformers for low voltage halogen lamps for independent use.</i></p>	<p>Bianco <i>White</i></p>	25	79	11,38



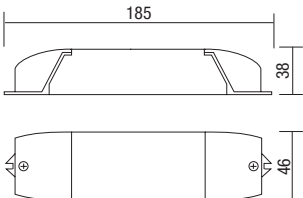

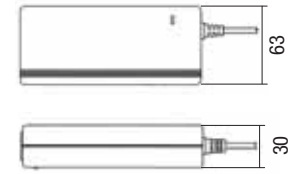

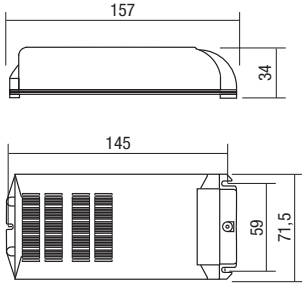
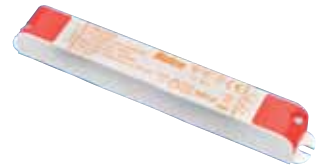
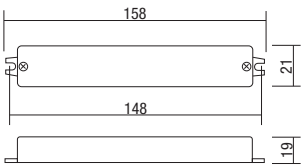

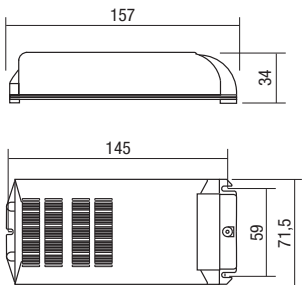

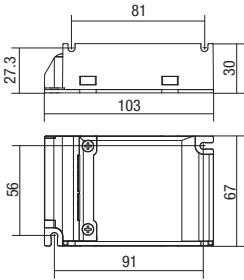
Apparecchi modulari per barra DIN - *Modular system for DIN track*

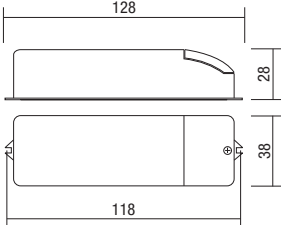

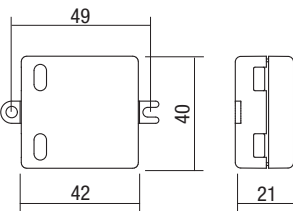

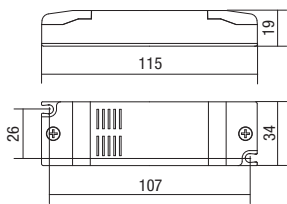

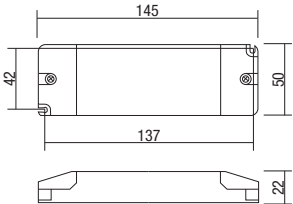
Articolo - Article	mm	Cod.	Descrizione - Description	Colore Colour	Pack	QTY	Euro
	1 DIN Modul	06110178RL	MTN 1P C10A In = 10A - 230-400Vac - 50/60Hz Interruttore magnetotermico per uso industriale <i>Miniature circuit breakers for industrial use</i>	Bianco <i>White</i>	12	1.184	1,30
		06110179RL	MTN 1P C16A In = 16A - 230-400Vac - 50/60Hz Interruttore magnetotermico per uso industriale <i>Miniature circuit breakers for industrial use</i>	Bianco <i>White</i>	12	2.257	1,30
		06110180RL	MTN 1P C20A In = 20A - 230-400Vac - 50/60Hz Interruttore magnetotermico per uso industriale <i>Miniature circuit breakers for industrial use</i>	Bianco <i>White</i>	12	3.125	1,30
		06110181RL	MTN 1P C25A In = 25A - 230-400Vac - 50/60Hz Interruttore magnetotermico per uso industriale <i>Miniature circuit breakers for industrial use</i>	Bianco <i>White</i>	12	2.980	1,30
		06110182RL	MTN 1P C32A In = 32A - 230-400Vac - 50/60Hz Interruttore magnetotermico per uso industriale <i>Miniature circuit breakers for industrial use</i>	Bianco <i>White</i>	12	782	1,30
		06110183RL	MTN 1P C40A In = 40A - 230-400Vac - 50/60Hz Interruttore magnetotermico per uso industriale <i>Miniature circuit breakers for industrial use</i>	Bianco <i>White</i>	12	537	1,30
		06120205RL	MTN 1P+N C10A In = 10A - 230-400Vac - 50/60Hz Interruttore magnetotermico per uso industriale <i>Miniature circuit breakers for industrial use</i>	Bianco <i>White</i>	12	201	1,90
	2 DIN Modul	06220171RO	RKP 1P+N C32A 30mA In = 32A - 230Vac - 50/60Hz Interruttore magnetotermico differenziale, tipo AC <i>Residual current circuit breakers, AC type</i>	Bianco <i>White</i>	6	54	8,00
		06220103RO	RKN 2P 25A 30mA In = 25A - 240Vac - 50/60Hz Interruttore differenziale puro, tipo AC - <i>Residual current miniature circuit breakers, AC type</i>	Bianco <i>White</i>	6	66	9,00
	4 DIN Modul	R00815	AL7-12 5W - 230Vac - 50/60Hz Alimentatore stabilizzato, carica batteria <i>Power adapter stabilised, battery charge</i>	Bianco <i>White</i>	1	472	8,00
	2 DIN Modul	EMM1012	EMM1012 230Vac - 50/60Hz Trasformatori di sicurezza per campanelli <i>Safety transformer for bells</i>	Bianco <i>White</i>	2	514	8,00
		EMM1512	EMM1512 230Vac - 50/60Hz Trasformatori di sicurezza per campanelli <i>Safety transformer for bells</i>	Bianco <i>White</i>	2	1.165	6,00

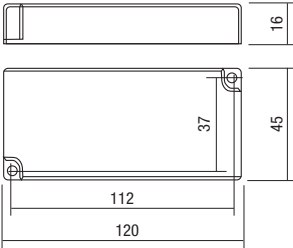
LED DRIVER

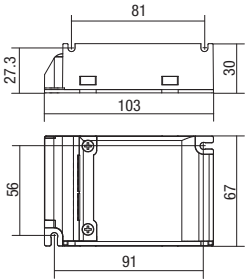

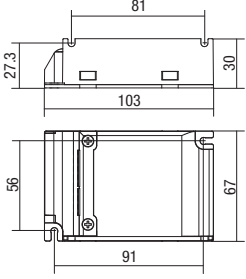

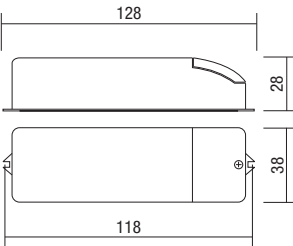

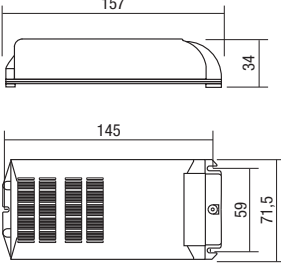

Articolo - Article		Dimensioni - Dimensions (mm)	Cod.	Descrizione - Description	Colore Colour	Pack	QTY	Euro
	10V		PTDC/10/10V/B	VDT PTDC/10/10V/B 8W - 10Vdc - 95-240V 50/60Hz Alimentatore non dimmerabile con uscita in tensione <i>Not dimmable power supply with output voltage</i>	Bianco White	1	93	3,70
	12V		PTDC/40/12V/N	VDT PTDC/40/12V/N 40W - 12Vdc - 115-230Vac 50/60Hz Alimentatore non dimmerabile con uscita in tensione <i>Not dimmable power supply with output voltage</i>	Bianco Arancio White Orange	10	7.790	9,00
	12V		PTDC/90/12V/N	VDT PTDC/90/12V/N 90W - 12Vdc - 100-240Vac 50/60Hz Alimentatore non dimmerabile con uscita in tensione <i>Not dimmable power supply with output voltage</i>	Nero Black	10	276	21,20
	24V		PTDC10U24VB	 VDT PTDC10U24VB 8,4W - 24Vdc - 176-264Vdc IN 95-240Vac IN - 50/60Hz Alimentatore non dimmerabile con uscita in tensione <i>Not dimmable power supply with output voltage</i>	Bianco White	1	488	4,00
	24V	L x P x H (mm) 202x20x20	RN1404	VDT IP65 MINILED 24V-13W 13W - 24Vdc - 100-240Vac 50/60Hz Alimentatore non dimmerabile con uscita in tensione <i>Not dimmable power supply with output voltage</i>	Bianco White	1	270	10,50
	24V		RN1462	VDT MINILED FLAT 24-15W 15W - 24Vdc - 220-240Vac 50/60Hz Alimentatore non dimmerabile con uscita in tensione <i>Not dimmable power supply with output voltage</i>	Bianco Arancio White Orange	1	217	5,90

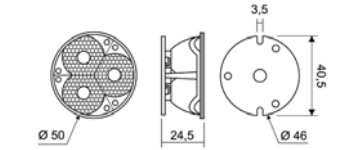

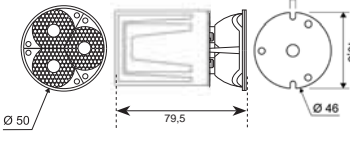

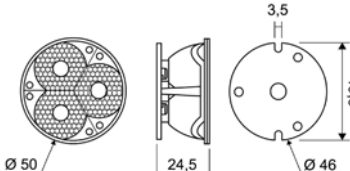

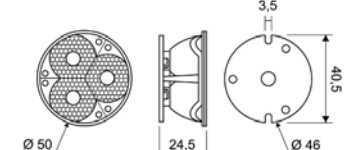

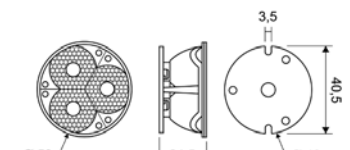

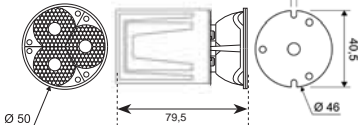
Articolo - Article		Dimensioni - Dimensions (mm)	Cod.	Descrizione - Description	Colore Colour	Pack	QTY	Euro
	24V	L x P x H (mm) 215x89x44	RN1361	VDT IP68 MINILED 68 15W - 24Vdc - 220-240Vac 50/60Hz Alimentatore non dimmerabile con uscita in tensione <i>Not dimmable power supply with output voltage</i>	Nero Black	1	357	11,20
	24V		PTDC/40/24V/N	VDT PTDC/40/24V/N 40W - 24Vdc - 115-230Vac 50/60Hz Alimentatore non dimmerabile con uscita in tensione <i>Not dimmable power supply with output voltage</i>	Bianco Arancio White Orange	1	1.275	9,00
	24V		PTDC/90/24V/N	VDT PTDC/90/24V/N 90W - 24Vdc - 100-240Vac IN 50/60Hz Alimentatore non dimmerabile con uscita in tensione <i>Not dimmable power supply with output voltage</i>	Nero Black	10	193	21,20
	24V DIM		PTDCD40S10B	VDT DIM PTDCD40S10B 13÷42W - 24Vdc 176-264Vdc IN 220-240Vac IN 50/60Hz Alimentatore dimmerabile con uscita in tensione <i>Dimmable power supply with output voltage</i>	Bianco White	1	203	12,30
	350mA		RN1395	CDT POWERLED SLIM 350-15W 15W - 350mA - 220-240Vac 50/60Hz Alimentatori NON Dimmerabili con uscita in corrente <i>NOT dimmable power supply with output current</i>	Bianco Arancio White Orange	1	1.478	6,00
	350mA		PTDC353- C350B	CDT PTDC353C350B 3x12,5W - 350mA 176-264Vdc IN 110-240Vac IN 50/60Hz Alimentatori NON Dimmerabili con uscita in corrente <i>NOT dimmable power supply with output current</i>	Bianco White	1	97	23,00

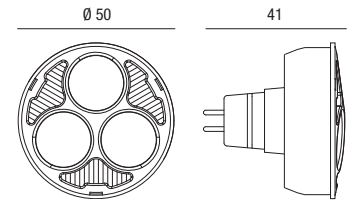

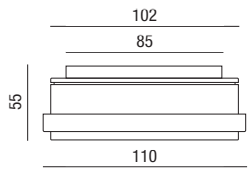

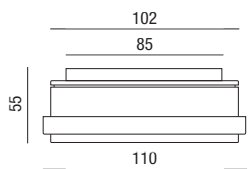

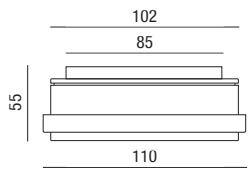

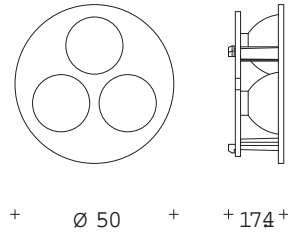

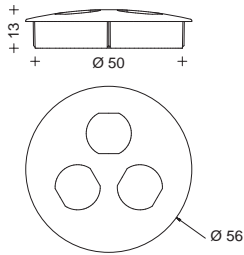
Articolo - Article		Dimensioni - Dimensions (mm)	Cod.	Descrizione - Description	Colore Colour	Pack	QTY	Euro
	350mA DIM		PTDCC1535010	CDT DIM PTDCC1535010 17W - 350mA - 220-240Vac 50/60Hz Alimentatori dimmerabili con uscita in corrente <i>Dimmable power supply with output current</i>	Bianco White	1	1.329	6,93
	500mA		RN1379	CDT POWERLED 500-12W 12W - 500mA - 220-240V 50/60Hz Alimentatori NON Dimmerabili con uscita in corrente <i>NOT dimmable power supply with output current</i>	Bianco White	1	65	9,00
	700mA		RN1348	CDT POWERLED 700-3W 3W - 700mA - 100-240Vac 50/60Hz Alimentatori NON Dimmerabili con uscita in corrente <i>NOT dimmable power supply with output current</i>	Nero Black	10	581	3,30
	700mA		PTDCC10U700B	CDT PTDCC10U700B 6,3W - 700mA - 176-264Vdc IN 95-240Vac IN 50/60Hz Alimentatori NON Dimmerabili con uscita in corrente <i>NOT dimmable power supply with output current</i>	Bianco White	1	304	3,80
	700mA		RN1402	CDT POWERLED 700-12W 12W - 700mA - 100-240Vac - 50/60Hz Alimentatori NON Dimmerabili con uscita in corrente <i>NOT dimmable power supply with output current</i>	Bianco Arancio White Orange	1	260	9,35
	700mA		RN1425	CDT POWERLED 700-12W 12W - 700mA - 220-240Vac 50/60Hz Alimentatori NON Dimmerabili con uscita in corrente <i>NOT dimmable power supply with output current</i>	Bianco White	1	211	6,70

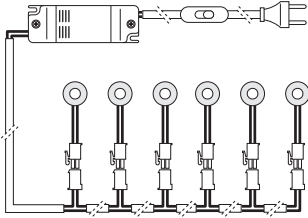

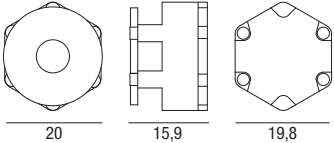

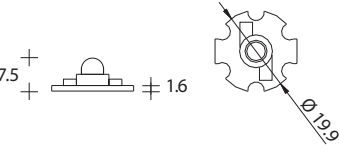

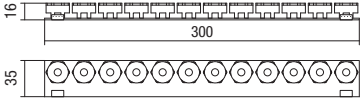

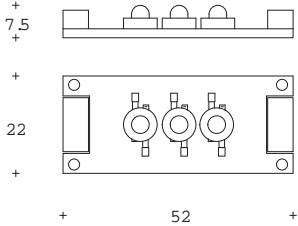

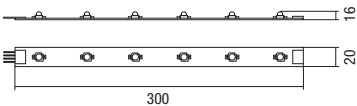
Articolo - Article		Dimensioni - Dimensions (mm)	Cod.	Descrizione - Description	Colore Colour	Pack	QTY	Euro
	700mA DIM		PTDCCD1570010	CDT DIM PTDCCD1570010 17W - 700mA - 176-264Vdc IN 220-240Vac IN - 50/60Hz Alimentatori dimmerabili con uscita in corrente <i>Dimmable power supply with output current</i>	Bianco <i>White</i>	1	736	8,00
	700mA DIM		PTDCCD15700SL (Slave)	CDT DIM PTDCCD15700SL 17W - 700mA - 176-264Vdc IN 220-240Vac IN - 50/60Hz Alimentatori dimmerabili con uscita in corrente <i>Dimmable power supply with output current</i>	Bianco <i>White</i>	1	382	10,40
	1050mA		RN1381	CDT POWERLED 1050-22W 22W - 1050mA - 220-240Vac 50/60Hz Alimentatori NON Dimmerabili con uscita in corrente <i>NOT dimmable power supply with output current</i>	Bianco <i>White</i>	1	161	11,10
	1050mA		PTDCC40100B	CDT PTDCC40100B 38W - 1050mA - 220-240Vac 50/60Hz Alimentatori NON Dimmerabili con uscita in corrente <i>NOT dimmable power supply with output current</i>	Bianco <i>White</i>	1	227	14,00

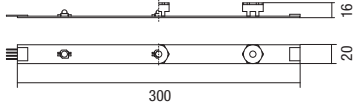
Moduli LED - LED module

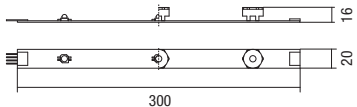
Articolo - Article	Dimensioni - Dimensions (mm)	Cod.	Descrizione - Description	LED	Pack	QTY	Euro
		R00054/IP	VDT POWER LED DICRO SPL 3W 3W - 12-24 Ac/Dc Led di potenza con driver incorporato bassa tensione. Compatibile con tutti gli apparecchi con foro Ø 50mm <i>Lower voltage power Led with built-in driver. Compatible with all the lighting system with hole Ø 50mm</i>	6000K	1	230	5,00
		R00056/IP	VDT POWER LED DICRO SPL 9W 9W - 12-24 Ac/Dc - 6000K Led di potenza con driver incorporato bassa tensione. Compatibile con tutti gli apparecchi con foro Ø 50mm <i>Lower voltage power Led with built-in driver. Compatible with all the lighting system with hole Ø 50mm</i>	6000K	1	38	5,00
		OSV/10/LK3/B 10°	VDT Optospot OSV3 4,4W - 12-24 Ac/Dc Modulo 3 LED con lenti incorporate. Compatibile con tutti gli apparecchi con foro Ø 50mm <i>3 leds module with built-in lenses Compatible with all the lighting system with hole Ø 50mm</i>	6000K	5	282	5,00
		OSV/10/LK3/BC 10°		3000K	5	189	5,00
		OSV/10/LK3/BL 10°		Led Blu Blue Led	5	200	5,00
		OSV/25/LK3/B 25°		6000K	5	375	5,00
		OSV/25/LK3/BC 25°		3000K	5	336	5,00
		OSV/40/LK3/B 40°		6000K	5	268	5,00
		OSV/40/LK3/BC 40°		3000K	5	44	5,00
		R00054	CDT POWER LED DICRO K2 3W 3W - 350mA Modulo 3 LED da 1W con lenti incorporate. Compatibile con tutti gli apparecchi con foro Ø 50mm <i>3 leds module - 1W each led - built-in lenses. Compatible with all the lighting system with hole Ø 50mm</i>	6000K	1	1.118	5,00
		30898	CDT POWER LED DICRO RGB 3x3W - 350mA Modulo 3 LED da 3W con lenti incorporate. Compatibile con tutti gli apparecchi con foro Ø 50mm <i>3 leds module - 3W each led - built-in lenses. Compatible with all the lighting system with hole Ø 50mm</i>	RGB	1	120	59,71

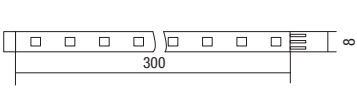
Articolo - Article	Dimensioni - Dimensions (mm)	Cod.	Descrizione - Description	LED	Pack	QTY	Euro	
		R00056	CDT POWER LED DICRO K2 9W 9W - 350mA Modulo 3 LED da 3W con lenti incorporate. Compatibile con tutti gli apparecchi con foro Ø 50mm	6000K	1	1.554	5,00	
		R00057	3 leds module - 3W each led - built-in lenses. Compatible with all the lighting system with hole Ø 50mm	Led Blu Blue Led	1	575	14,93	
		ODL15GU5.3KB	VDI Dicroled ODL/GU5,3 Max 3,5W - 12-24 Vdc - 6000K	6000K	5	266	5,00	
		ODL30GU5.3KBC	Lampada Led MR16 con lente incorporata e 3 LED di potenza - Attacco per connessione GU53	3000K	5	164	5,00	
		ODL30GU5.3KB	Led lamp MR16 with built in lens and equipped with 3 high power LEDs	6000K	5	226	5,00	
		R00063	CDT KIT AR111 POWER LUMILED 15W - 700mA	6000K	1	1.583	5,00	
		R00065	Led di potenza con driver incorporato. Compatibile con faretti per lampade AR111 Power Led with built-in driver Suitable for AR111 spot-lights	3000K	1	268	5,00	
		30891	CDT KIT AR111 POWER LUMILED 30W - 700mA	3000K	1	92	50,59	
		30890	Led di potenza con driver incorporato. Compatibile con faretti per lampade AR111 Power Led with built-in driver Suitable for AR111 spot-lights	6000K	1	55	47,73	
		30897	CDT KIT AR111 RGB 15W - 350mA	RGB	1	59	47,94	
		OSP/LP15/L3/B	CDT Optospot OSP3LP 3W - 350mA Modulo 3 LED da 1W con lenti incorporate. Compatibile con tutti gli apparecchi con foro Ø 50mm 3 leds module - 1W each led - built-in lenses 30°. Compatible with all the lighting system with hole Ø 50mm	6000K	5	374	5,00	
		OSP/LP15/L3/B		15°	3000K	5	82	5,00
		OSP/LP15/L3/BL		15°	Led Blu Blue Led	5	290	5,00
		OSP/LP15/L3/V		15°	Led Verde Green Led	5	25	5,00
		OSP/LP30/L3/BL		30°	Led Blu Blue Led	5	117	5,00
		OSP/LP30/L3/R		30°	Led Rosso Red Led	5	20	5,00

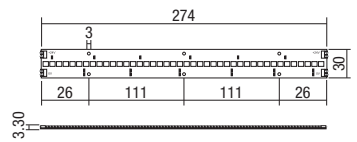
Articolo - Article	Dimensioni - Dimensions (mm)	Cod.	Descrizione - Description	LED	Pack	QTY	Euro
		OSP/L45B/L3/B 45°	CDT Optospot OSP3 3W - 350mA Modulo 3 LED da 1W con lenti incorporate. Compatibile con tutti gli apparecchi con foro Ø 50mm	6000K	5	216	5,00
		OSP/L45B/L3/G 45°	CDT 3 leds module - 1W each led - built-in lenses. Compatible with all the lighting system with hole Ø 50mm	Giallo Yellow	5	60	5,00
		KIT/60SP1/BC	CDT KIT/OSP 6W - 350mA Kit led con alimentatore da 10W-350mA, cablato spina più rompifilo, catenaria con connettori rapidi.	3000K	1	91	27,49
		KIT/60SP1/B	CDT Led kit completely wired with fast connection and 10Watt-350mA power supply, plug and switch cordset.	6000K	1	51	25,77
		OSP/LP15/L1/BC	CDT OPTOSPOT OSP1P 1W - 350mA - 6000K Modulo Led con lente incorporata 15° <i>Led module with built-in lens 15°</i>	3000K	10	248	3,23
		SL1/E20/C/BC	CDT Modulo LED con o senza lente incorporata, con un LED di potenza da 1W~ a 350 mA. Da utilizzarsi con alimentatori elettronici VLM CDT a corrente costante 350 mA. <i>LED module with or without built-in lens, equipped with a high power 1W~ 350 mA LED. To be used with 350 mA constant current VLM CDT power supply.</i>	3000K	10	1.289	2,49
		OSMLP30L12RGB	CDT Strip RGB con dodici LED di potenza da 1W~ a 350 mA. Lenti da 30°. Da utilizzarsi con dimmer controllo colore CDT a corrente costante 350 mA. <i>RGB strip with twelve high power 1W~ 350 mA LEDs. 30° lenses. To be used with 350 mA CDT constant current RGB dimmer.</i>	RGB	4	135	42,57
		OSM2252LM3RGB	CDT Modulo con tre LED di potenza da 1W~ a 350 mA. Da utilizzarsi con dimmer controllo colore CDT a corrente costante 350 mA. <i>RGB module with three high power 1W~ 350 mA LEDs. To be used with CDT 350 mA constant current RGB dimmer.</i>	RGB	20	92	8,64

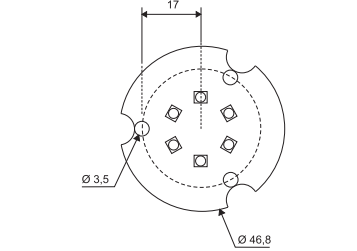
Articolo - Article	Dimensioni - Dimensions (mm)	Cod.	Descrizione - Description	LED	Pack	QTY	Euro
		OSV20300L6BC	<p>VDT</p> <p>Strip con 6 LED di potenza. Provvista di terminali di connessione. Schede connettabili in cascata max: 8 (12 V DC) - 16 (24 V DC). Da usare con alimentatori a tensione d'uscita costante.</p> <p><i>Led strip with 6 high power LED. Provided with connection pins. Max modules for cascade connection: 8 (12 V DC) - 16 (24 V DC). To be used with constant voltage power supplies.</i></p>	3000K	5	445	14,95
		OSV20300L3BC	<p>VDT</p> <p>Strip con 3 LED di potenza, con lenti da 120°. Provvista di terminali di connessione. Schede connettabili in cascata max: L3 16 (12 V DC) - 32 (24 V DC); LT3 8 (12 V DC) - 16 (24 V DC). Da usare con alimentatori a tensione d'uscita costante VDT.</p> <p><i>Led strip with 3 high power LED, 120° lenses. Provided with connection pins. Max modules for cascade connection: L3 16 (12 V DC) - 32 (24 V DC); LT3 8 (12 V DC) - 16 (24 V DC). To be used with constant voltage VDT power supplies.</i></p>	3000K	5	482	9,17
		OSV2030030L3B	<p>VDT</p> <p>Strip con 3 LED di potenza, con lenti da 30°. Provvista di terminali di connessione. Schede connettabili in cascata max: L3 16 (12 V DC) - 32 (24 V DC); LT3 8 (12 V DC) - 16 (24 V DC). Da usare con alimentatori a tensione d'uscita costante VDT.</p> <p><i>Led strip with 3 high power LED, with 30° lenses. Provided with connection pins. Max modules for cascade connection: L3 16 (12 V DC) - 32 (24 V DC); LT3 8 (12 V DC) - 16 (24 V DC). To be used with constant voltage VDT power supplies.</i></p>	6000K	5	100	10,39
		OSM8300S15B	<p>VDT</p> <p>Strip LED con 5 o 15 LED SMD. Provvista di terminali di connessione. Da usare con alimentatori a tensione d'uscita costante VDT.</p> <p><i>Strip LED with 5 or 15 LED SMD. Provided with connection pins. To be used with constant voltage VDT power supplies.</i></p>	6000K	10	590	6,14
		OSM8/300/S5/B	<p><i>Strip LED with 5 or 15 LED SMD. Provided with connection pins. To be used with constant voltage VDT power supplies.</i></p>	6000K	10	417	2,72
		OSV30/L21/B	<p>VDT</p> <p>Strip LED con 21 LED SMD 5630 provvista di terminali di connessione. Schede collegabili: max 5. Posizionare su superficie metallica dissipante.</p> <p><i>LED Strip with 21 LED SMD 5630 provided with connector pins. Max number of strips connection: max 5 Place on dissipating metal surface.</i></p>	6000K	20	535	3,28
			<p>VDT</p> <p>Top LED Modulo 6 LED - 6 LED Module 1W - 12Vdc - 13Lm - 120°</p>	Verde Green	1	131	5,34