

idee Luce

 **segno**
Since 1983



“Nella vita è fondamentale avere ambizioni
e la giusta volontà di mettersi in gioco”

*“In life it is essential to have ambitions
and the right willingness to get involved”*



Aura S
suspension up & down
Pag. 458 - 467



Aura S verticale, multi Aura
suspension up & down
Pag. 468 - 473



Aura W
wall up & down
Pag. 474



Aura track verticale
track up & down
Pag. 476



Giacinto - Ego - Baby
wall, ceiling
Pag. 490



Jodie S
suspension
Pag. 491



Vetro Palla S
suspension
Pag. 494



Vittoria, Fatua
table
Pag. 495



Pendel
suspension
Pag. 478



Zero - Mario
suspension
Pag. 479



Geranio 3S - Geranio 7S
suspension
Pag. 480



Glicine S
suspension
Pag. 481



Jeri S
suspension
Pag. 496



Aki - Cupo - Font - Milu
wall
Pag. 498



Ariete tondo
wall, ceiling
Pag. 500



Sovraspecchio
wall
Pag. 502



Agave C - Diphylleia S
suspension
Pag. 482



Orchidea S
suspension
Pag. 482



Ibisco S - Lilla S - Calla S
suspension
Pag. 483



Gerbera S - Lavanda S
suspension
Pag. 484



Specchio serie
wall
Pag. 503



Gerbera F - Nandina F
floor
Pag. 504

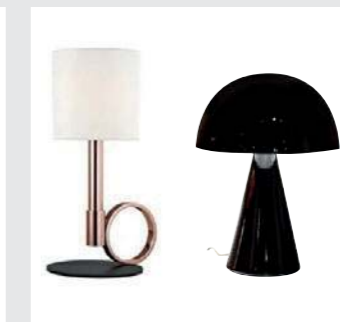

Buddleja T - Lavanda T
floor - table
Pag. 504



Smart
floor, table
Pag. 505



Hemisphere S
suspension
Pag. 484



Girasole
ceiling, Wall, Floor, Table
Pag. 485



Lisianthus - Anthurium
wall
Pag. 489



FLEX applique Black
wall
Pag. 489



LED Po, LED Tevere lanterna
table
Pag. 506



LED Reno, LED Piave
floor, table
Pag. 507



Ventilatori
ceiling
Pag. 508



Lampadine LED LED bulbs
Vedi/See: Components Catalogue

Aura

UGR<17



Design: Giancarlo Tintori

Cerchi luminosi dalle linee essenziali a doppia emissione a sviluppo orizzontale declinati in versione verticale e a cascata grazie ai rosoni studiati per alimentare multilampade, il tutto abbinabile ad una elegante versione a parete disponibile in due misure.

Estremamente versatile può esistere in sospensioni singole o in composizioni a varie altezze a creare effetti scenografici.

Ideali per ambienti residenziali, uffici e spazi pubblici, realizzati con anelli in alluminio equipaggiati con LED SMD integrati, compatibili con interruttore dimmer e cavi regolabili in altezza.

Emissione: diretta, indiretta o entrambe le emissioni.

Diffusori in gomma ai siliconi; ottica diffondente opale ad alta trasmittanza.

Cri: 90

Colore: 4 colori disponibili bianco lucido RAL 9010, nero opaco RAL 9005, grigio RAL9006, oro satinato, Bronzo RAL8028.

Comando: con normale interruttore ON-OFF (2 fili + terra).
DIM **DALI 2** PUSH (4 fili + terra) .

Temperatura di colore: colorazione standard bianco 3000K a richiesta bianco caldo 2700K e bianco neutro 4000K.

Ugr: UGR ≤17.

Luminous circles with essential lines with double emission and horizontal development available in vertical and cascade versions thanks to the rosettes designed to power multiple lamps, all combined with an elegant wall version in two sizes.

Extremely versatile, it can exist in single suspensions or in compositions at various heights to create scenographic effects.

Ideal for residential environments, offices and public spaces, made with aluminum rings equipped with integrated SMD LEDs, compatible with dimmer switch and height-adjustable cables.

Emission: direct, indirect or both emissions.

Silicone rubber diffusers; opal diffusing optic with high transmittance.

Cri: 90

Colour: 5 colours available: Polished white RAL 9010, opal black RAL 9005, grey RAL9006, satin gold, Bronze RAL8028.

Control: with normal ON-OFF switch (2 wires + earth).
DIM **DALI 2** PUSH (4 wires + earth).

Colour temperature: standard color white 3000K on request warm white 2700K and neutral white 4000K.

Ugr: UGR ≤17.



Versioni Bluetooth a richiesta
Bluetooth version on request



APP
proprietaria Relco.
Relco proprietary APP.



DIMBTDA
Varialuce/Dimmer
Bluetooth DALI 2

Max 40 DEVICE 2 DEVICE 1



Ecosistema Bluetooth DALI2 in grado di controllare fino a 40 driver DALI.

Con rete wireless Bluetooth mesh 5.0 rende la comunicazione tra apparecchi molto più semplice senza un lungo cablaggio, che alla fine consente di risparmiare sui costi progetti (specialmente per progetti di aggiornamento retrofit).

La configurazione e la messa in servizio del dispositivo possono essere eseguite tramite app proprietaria Relco.

Ecosystem Bluetooth DALI2 is able to control up to 40 LED drivers.

The Bluetooth mesh 5.0 wireless network greatly simplifies communication between the devices without long wires, ultimately saving on design costs (especially for retrofit update projects).

The device can be configured and put into service using the Relco proprietary app.



Aura S LED 1 anello Up & Down

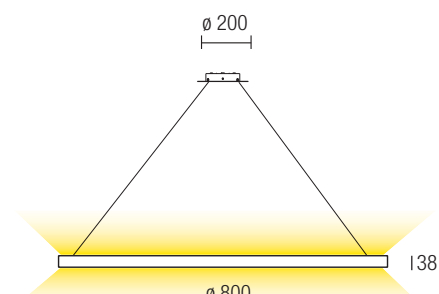
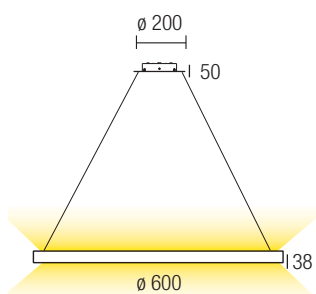
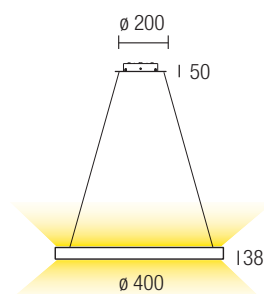

AURA S 40 Up & Down

	ON -OFF	DALI 2 PUSH
	762001-3KB	762001-3KBDA
	762001-3KN	762001-3KNDA
	762001-3KG	762001-3KGDA
	762001-3KO	762001-3KODA
	762001-3KBR	762001-3KBRDA

Sorgente Source

Potenza Total power 2x20W

Temperatura di colore Color temperature **3000K**
2700K-4000K ON DEMAND

Flusso luminoso max. Lighting output max. 2x1000Lm (50lm/W)

Peso kg weight kg 1,5

Lunghezza cavi L. max Cable length L. max 2200mm

220-240V 50/60Hz DRIVER INCLUDED

AURA S 60 Up & Down

	ON -OFF	DALI 2 PUSH
	772001-3KB	772001-3KBDA
	772001-3KN	772001-3KNDA
	772001-3KG	772001-3KGDA
	772001-3KO	772001-3KODA
	772001-3KBR	772001-3KBRDA

Sorgente Source

Potenza Total power 2x30W

Temperatura di colore Color temperature **3000K**
2700K-4000K ON DEMAND

Flusso luminoso max. Lighting output max. 2x1500Lm (50lm/W)

Peso kg weight kg 2,25

Lunghezza cavi L. max Cable length L. max 2200mm

220-240V 50/60Hz DRIVER INCLUDED

AURA S 80 Up & Down

	ON -OFF	DALI 2 PUSH
	772002-3KB	772002-3KBDA
	772002-3KN	772002-3KNDA
	772002-3KG	772002-3KGDA
	772002-3KO	772002-3KODA
	772002-3KBR	772002-3KBRDA

Sorgente Source

Potenza Total power 2x30W

Temperatura di colore Color temperature **3000K**
2700K-4000K ON DEMAND

Flusso luminoso max. Lighting output max. 2x1500Lm (50lm/W)

Peso kg weight kg 3,0

Lunghezza cavi L. max Cable length L. max 2200mm

220-240V 50/60Hz DRIVER INCLUDED

Aura S LED 1 anello Up & Down



AURA S 120 Up & Down

ON - OFF

DALI 2 PUSH

	772003-3KB	772003-3KBDA
	772003-3KN	772003-3KNDA
	772003-3KG	772003-3KGD
	772003-3KO	772003-3KODA
	772003-3KBR	772003-3KBRDA

Sorgente
Source



Potenza
Total power 2x40W

Temperatura di colore
Color temperature **3000K**

2700K-4000K
ON DEMAND

Flusso luminoso max.
Lighting output max. 2x2000Lm
(50lm/W)

Peso kg
weight kg 3,75

Lunghezza cavi L. max
Cable length L. max 2200mm

   CELL

220-240V 50/60Hz DRIVER INCLUDED

Aura Ø800, Ø1200 con possibilità di accensioni separate.

Nuove versioni biemissione più performanti complete di driver e moduli LED ad alta efficienza, possono utilizzare accensioni separate per emissione indiretta verso l'alto, diretta verso il basso oppure in entrambe le direzioni. La sorgente luminosa è posizionata in modo da ottenere una luce discreta ed efficace senza la percezione dell'abbagliamento.

Aura Ø800, Ø1200 with the possibility of separate ignitions.

New, more performing dual-emission versions complete with high-efficiency LED drivers and modules can use separate switching for indirect emission upwards, direct downwards or in both directions. The light source is positioned so as to obtain a discreet and effective light without the perception of glare.

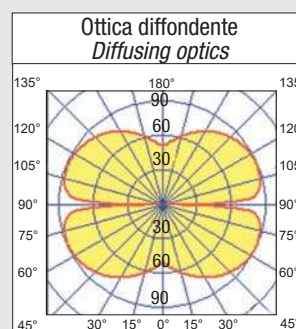
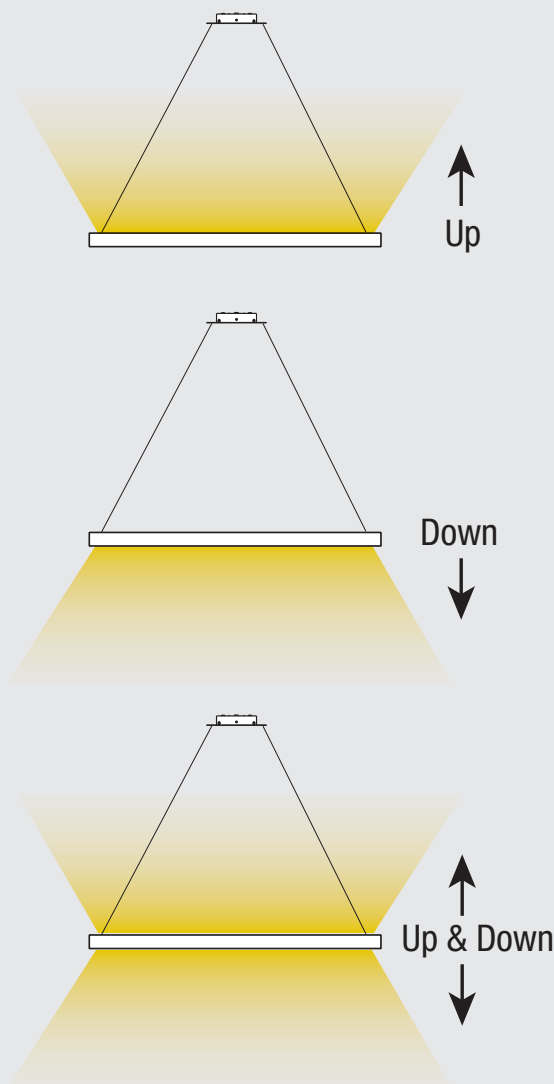





Aura S LED 2, 3 anelli

Up & Down

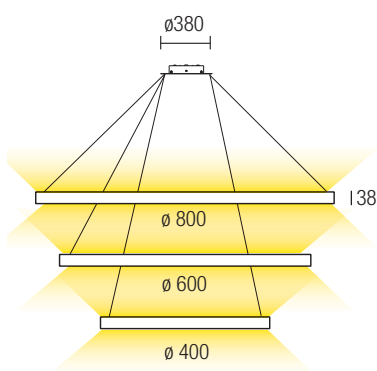
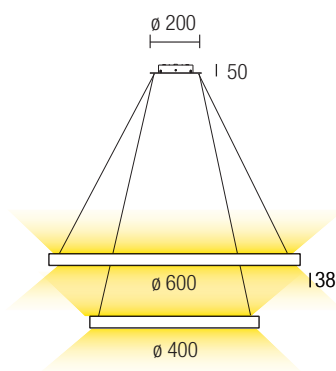
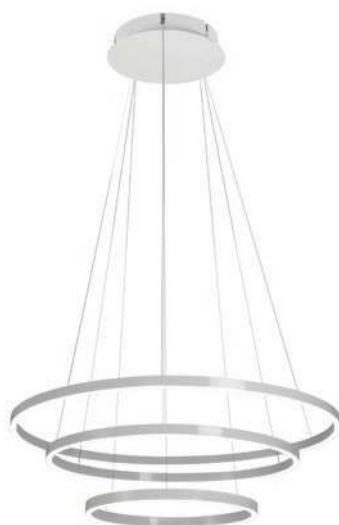

AURA S 40-60 Up & Down

ON - OFF

DALI 2 PUSH

	782002-3KB	782002-3KBDA
	782001-3KN	782001-3KNDA
	782001-3KG	782001-3KGDA
	782001-3KO	782001-3KODA
	782001-3KBR	782001-3KBRDA

Sorgente
Source



Potenza
Total power 2x50W

Temperatura di colore
Color temperature **3000K**

Flusso luminoso max.
Lighting output max. 2x2500Lm
(50lm/W)

Peso kg
weight kg 3,75

Lunghezza cavi L. max
Cable length L. max 2200mm



   

220-240V 50/60Hz DRIVER INCLUDED

AURA S 40-60-80 Up & Down

ON - OFF

DALI 2 PUSH

	802002-3KB	802002-3KBDA
	802001-3KN	802001-3KNDA
	802001-3KG	802001-3KGDA
	802001-3KO	802001-3KODA
	802001-3KBR	802001-3KBRDA

Sorgente
Source



Potenza
Total power 2x80W

Temperatura di colore
Color temperature **3000K**

Flusso luminoso max.
Lighting output max. 2x4000Lm
(50lm/W)

Peso kg
weight kg 6,75

Lunghezza cavi L. max
Cable length L. max 2200mm

   

220-240V 50/60Hz DRIVER INCLUDED







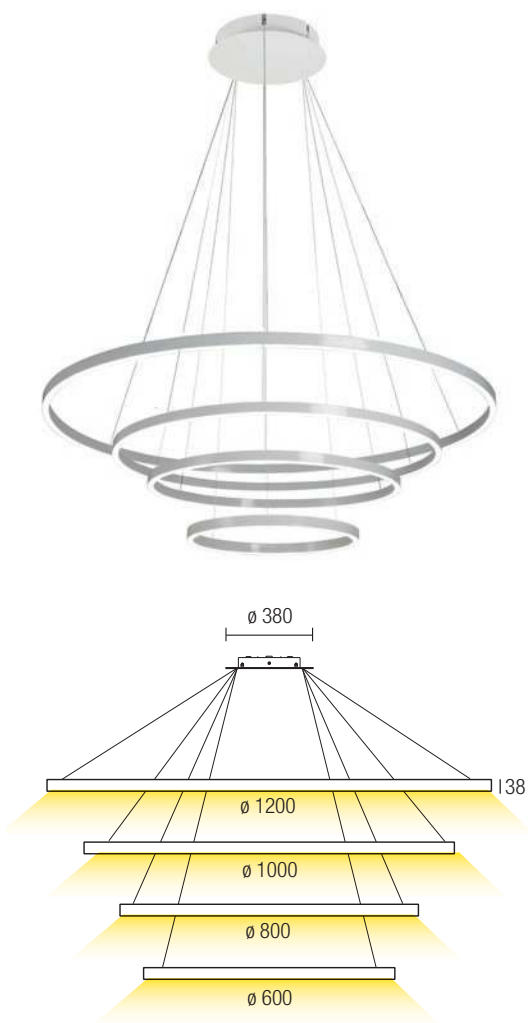

Aura S LED 4 anelli Down



AURA S 60-80-100-120 Down

ON - OFF

DALI 2 PUSH

	822002-3KB	822002-3KBDA
	822001-3KN	822001-3KNDA
	822001-3KG	822001-3KGDA
	822001-3KO	822001-3KODA
	822001-3KBR	822001-3KBRDA

Sorgente
Source

LED

Potenza
Total power

230W

Temperatura di colore
Color temperature

3000K

2700K-4000K
ON DEMAND

Flusso luminoso max.
Lighting output max.

11.500Lm
(50lm/W)

Peso kg
weight kg

8,0

Lunghezza cavi L. max
Cable length L. max

2200mm

   **CELL**

220-240V 50/60Hz DRIVER INCLUDED





Aura S LED Verticale 1 anello

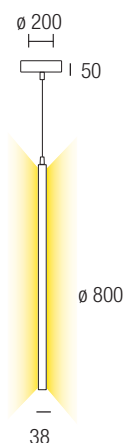
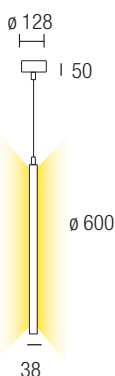
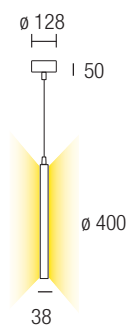
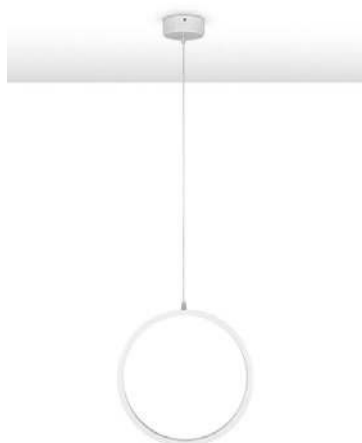

AURA S Verticale 40

ON - OFF



	7620VE-3KB	7620VE-3KBDA
	7620VE-3KN	7620VE-3KNDA
	7620VE-3KG	7620VE-3KGDA
	7620VE-3KO	7620VE-3KODA
	7620VE-3KBR	7620VE-3KBRDA

Sorgente
Source



Potenza
Total power

2x20W

Temperatura di colore
Color temperature

3000K

2700K-4000K
ON DEMAND

Flusso luminoso max.
Lighting output max.

2x1000Lm
(50lm/W)

Peso kg
weight kg

1,5

Lunghezza cavi L. max
Cable lenght L. max

2200mm



220-240V 50/60Hz DRIVER INCLUDED

AURA S Verticale 60

ON - OFF



	7720VE-3KB	7720VE-3KBDA
	7720VE-3KN	7720VE-3KNDA
	7720VE-3KG	7720VE-3KGDA
	7720VE-3KO	7720VE-3KODA
	7720VE-3KBR	7720VE-3KBRDA

Sorgente
Source



Potenza
Total power

2x30W

Temperatura di colore
Color temperature

3000K

2700K-4000K
ON DEMAND

Flusso luminoso max.
Lighting output max.

2x1500Lm
(50lm/W)

Peso kg
weight kg

2,25

Lunghezza cavi L. max
Cable lenght L. max

2200mm



220-240V 50/60Hz DRIVER INCLUDED

AURA S Verticale 80

ON - OFF



	7722VE-3KB	7722VE-3KBDA
	7722VE-3KN	7722VE-3KNDA
	7722VE-3KG	7722VE-3KGDA
	7722VE-3KO	7722VE-3KODA
	7722VE-3KBR	7722VE-3KBRDA

Sorgente
Source



Potenza
Total power

2x30W

Temperatura di colore
Color temperature

3000K

2700K-4000K
ON DEMAND

Flusso luminoso max.
Lighting output max.

2x1500Lm
(50lm/W)

Peso kg
weight kg

3,0

Lunghezza cavi L. max
Cable lenght L. max

2200mm



220-240V 50/60Hz DRIVER INCLUDED

Informazioni tecniche, collegamento elettrico

Technical information on electrical connection

Accensione singola con impianto tradizionale

Single ignition with traditional system

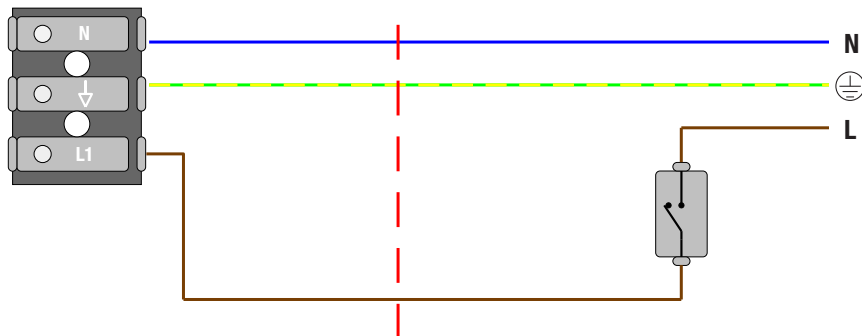
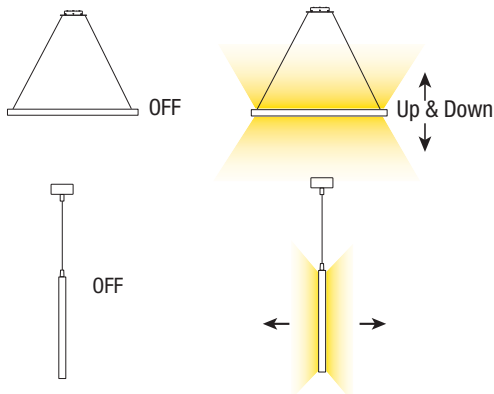

Accensione indipendente, impianto tradizionale + un filo Ø800, Ø1200.

Independent ignition, traditional system + one wire Aura Ø800, Ø1200 and two rings (Ø400 + Ø600).

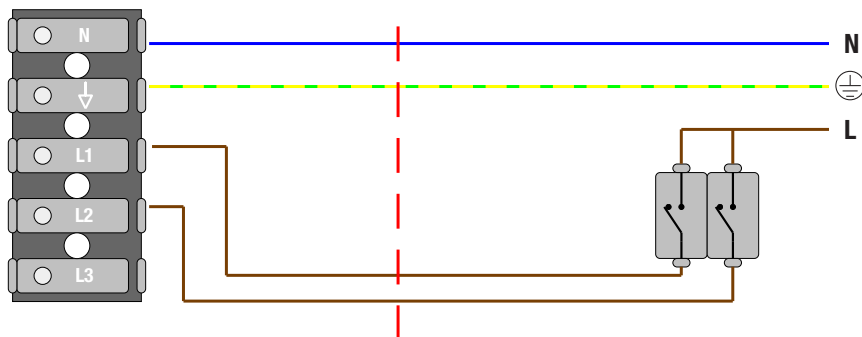
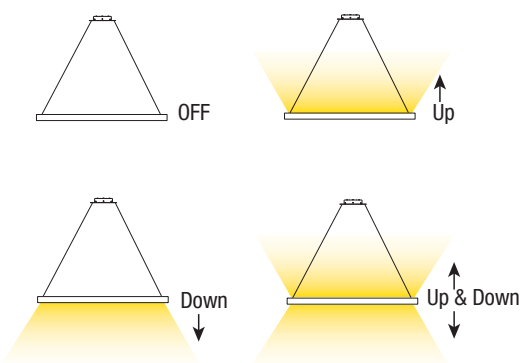

Dimmerabile DALI
Dimmable DALI

Regolazione Dali, impianto tradizionale + due fili

Dali regulation, traditional system + two wires

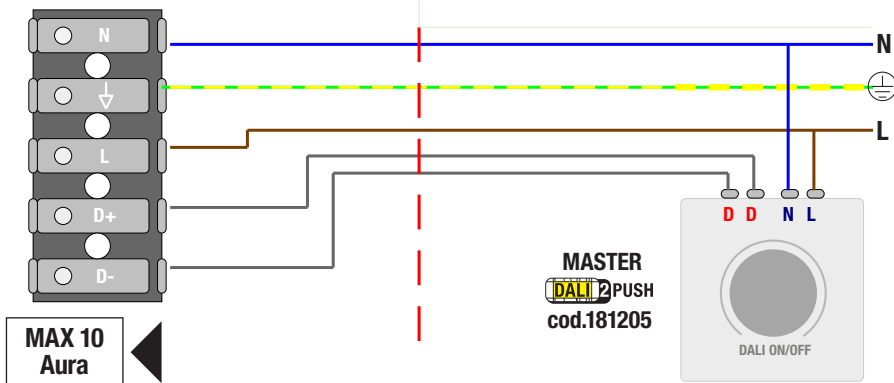
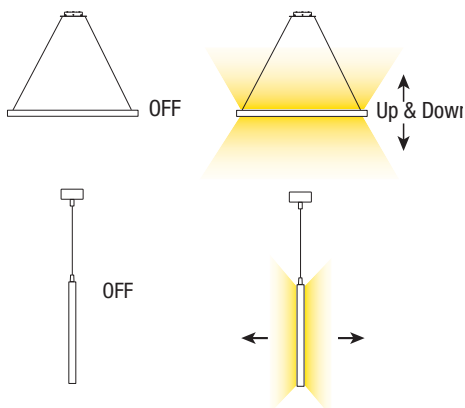

Dimmerabile PUSH
Dimmable PUSH

Regolazione a pulsante con driver Dali, impianto tradizionale + un filo

Push button adjustment with Dali driver, traditional system + one wire

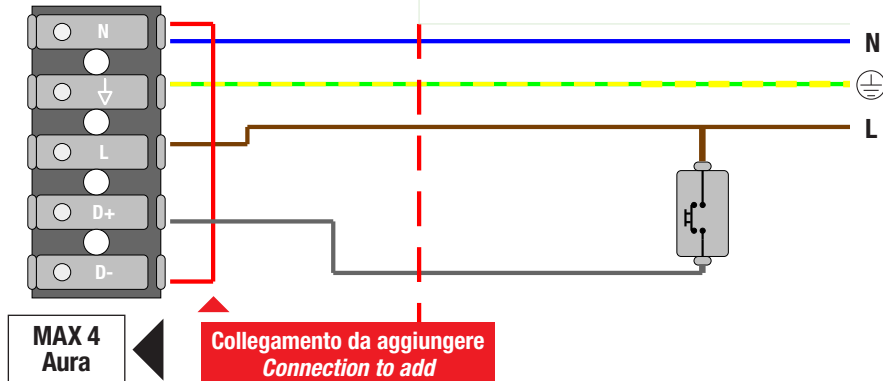
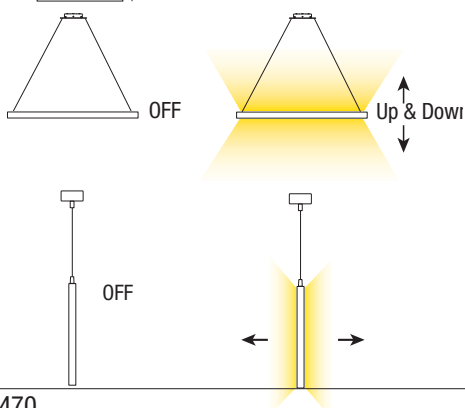



Aura S LED 3 anelli MultiAura



3X
Ø400mm



2X
Ø400mm

1X
Ø600mm



1X
Ø400mm

1X
Ø600mm

1X
Ø800mm

MULTIAURA S Verticale 3X40

ON -OFF

DALI 2 PUSH

	7620ML-3KB	7620VE-3KBDA
	7620ML-3KN	7620VE-3KNDA
	7620ML-3KG	7620VE-3KGDA
	7620ML-3KO	7620VE-3KODA
	7620ML-3KBR	7620VE-3KBRDA

Sorgente Source **LED**

Potenza Total power 2x60W

Temperatura di colore Color temperature **3000K**
2700K-4000K ON DEMAND

Flusso luminoso max. Lighting output max. 2x3000Lm (50lm/W)

Peso kg weight kg 6,1

Lunghezza cavi L. max Cable length L. max 2200mm



220-240V 50/60Hz DRIVER INCLUDED

MULTIAURA S Verticale 2X40 - 1X60

ON -OFF

DALI 2 PUSH

	7720ML-3KB	7720VE-3KBDA
	7720ML-3KN	7720VE-3KNDA
	7720ML-3KG	7720VE-3KGDA
	7720ML-3KO	7720VE-3KODA
	7720ML-3KBR	7720VE-3KBRDA

Sorgente Source **LED**

Potenza Total power 2x70W

Temperatura di colore Color temperature **3000K**
2700K-4000K ON DEMAND

Flusso luminoso max. Lighting output max. 2x3500Lm (50lm/W)

Peso kg weight kg 6,4

Lunghezza cavi L. max Cable length L. max 2200mm



220-240V 50/60Hz DRIVER INCLUDED

MULTIAURA S Verticale 1X40-1X60-1X80

ON -OFF

DALI 2 PUSH

	7722ML-3KB	7722VE-3KBDA
	7722ML-3KN	7722VE-3KNDA
	7722ML-3KG	7722VE-3KGDA
	7722ML-3KO	7722VE-3KODA
	7722ML-3KBR	7722VE-3KBRDA

Sorgente Source **LED**

Potenza Total power 2x80W

Temperatura di colore Color temperature **3000K**
2700K-4000K ON DEMAND

Flusso luminoso max. Lighting output max. 2x4000Lm (50lm/W)

Peso kg weight kg 7

Lunghezza cavi L. max Cable length L. max 2200mm



220-240V 50/60Hz DRIVER INCLUDED



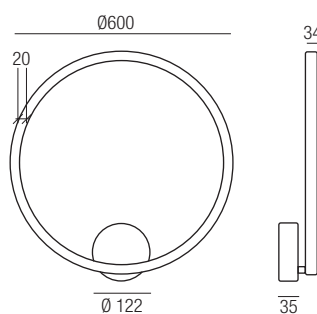
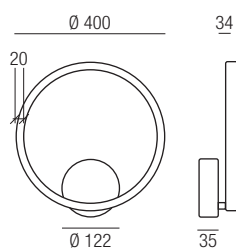

AURA W 40

ON - OFF

	8020AP-3KB	8020AP-3KBDA
	8020AP-3KN	8020AP-3KNDA
	8020AP-3KG	8020AP-3KGDA
	8020AP-3KO	8020AP-3KODA
	8020AP-3KBR	8020AP-3KBRDA

DALI 2 PUSH

	8020AP-3KBDA
	8020AP-3KNDA
	8020AP-3KGDA
	8020AP-3KODA
	8020AP-3KBRDA

Sorgente
Source



Potenza
Total power 2x20W

Temperatura di colore
Color temperature **3000K**

2700K-4000K
ON DEMAND

Flusso luminoso max.
Lighting output max. 2x1000Lm
(50lm/W)

Peso kg
weight kg 1,5

Lunghezza cavi L. max
Cable lenght L. max 2200mm



220-240V 50/60Hz DRIVER INCLUDED

AURA W 60

ON - OFF

	8120AP-3KB	8120AP-3KBDA
	8120AP-3KN	8120AP-3KNDA
	8120AP-3KG	8120AP-3KGDA
	8120AP-3KO	8120AP-3KODA
	8120AP-3KBR	8120AP-3KBRDA

DALI 2 PUSH

	8120AP-3KBDA
	8120AP-3KNDA
	8120AP-3KGDA
	8120AP-3KODA
	8120AP-3KBRDA

Sorgente
Source



Potenza
Total power 2x30W

Temperatura di colore
Color temperature **3000K**

2700K-4000K
ON DEMAND

Flusso luminoso max.
Lighting output max. 2x1500Lm
(50lm/W)

Peso kg
weight kg 2,25

Lunghezza cavi L. max
Cable lenght L. max 2200mm



220-240V 50/60Hz DRIVER INCLUDED







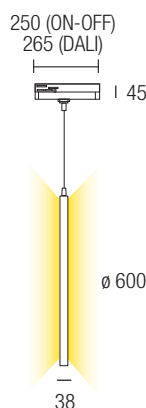
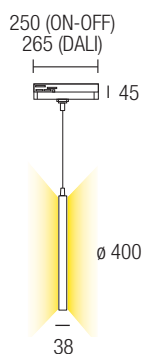

Aura Track Verticale 1 anello



AURA Track verticale 40

	ON - OFF	DALI 2 PUSH
	7620VTR-3KB	7620VTR-3KBDA
	7620VTR-3KN	7620VTR-3KNDA
	7620VTR-3KG	7620VTR-3KGDA
	7620VTR-3KO	7620VTR-3KODA
	7620VTR-3KBR	7620VTR3KBRDA

Sorgente Source 

Potenza Total power 2x20W

Temperatura di colore Color temperature **3000K**
2700K-4000K ON DEMAND

Flusso luminoso max. Lighting output max. 2x1000Lm (50lm/W)





Peso kg weight kg 1,5

Lunghezza cavi L. max Cable length L. max 2200mm



220-240V 50/60Hz DRIVER INCLUDED

AURA Track verticale 60

	ON - OFF	DALI 2 PUSH
	7720VTR-3KB	7720VTR-3KBDA
	7720VTR-3KN	7720VTR-3KNDA
	7720VTR-3KG	7720VTR-3KGDA
	7720VTR-3KO	7720VTR-3KODA
	7720VTR-3KBR	7720VTR3KBRDA

Sorgente Source 

Potenza Total power 2x30W

Temperatura di colore Color temperature **3000K**
2700K-4000K ON DEMAND

Flusso luminoso max. Lighting output max. 2x1500Lm (50lm/W)

Peso kg weight kg 2,25

Lunghezza cavi L. max Cable length L. max 2200mm





220-240V 50/60Hz DRIVER INCLUDED



Pendel Serie

Cavo in pvc da ordinare separatamente, rivestito textile 2x0,75mm² H03VV lunghezza 5 metri.

PVC cable to be ordered separately, textile coating 2x0.75mm² H03VV, 5 meters long.

Color	H mm	Code
 Oro Gold	5000	25.330
 Cromo Chrome	5000	25.345



LED
inside

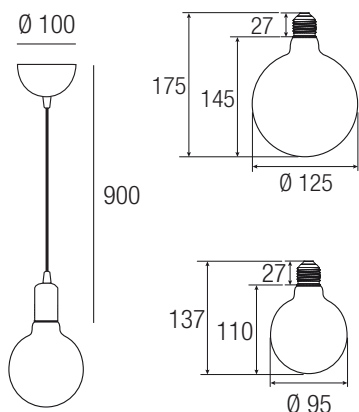

Solo pendel
Only pendel



LED
inside



LED
inside



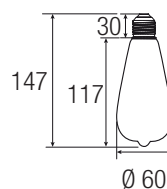

LED
inside



LED
inside



Pendelglobo inox



Color	Diffusor
 Cromo Chrome	 Trasparente Transparent

Code	Ø mm
555287.KIT	125
555338.KIT	95

Sorgente Source	
Potenza Total power	5W
Temperatura di colore Color temperature	3000K
Flusso luminoso Lighting output	550Lm
Lunghezza cavi L. max Cable lenght L. max	900mm

   S+L
220-240V 50/60Hz

Pendelglobo inox



Color	Diffusor
 Cromo Chrome	 Trasparente Transparent
 Cromo Chrome	

Code	Ø mm
555375.KIT	125
555348.KIT	95

Sorgente Source	
Potenza Total power	5W
Temperatura di colore Color temperature	3000K
Flusso luminoso Lighting output	550Lm
Lunghezza cavi L. max Cable lenght L. max	900mm

   S+L
220-240V 50/60Hz

Pendelglobo Antico

Color	Diffusor
 Oro Gold	 Trasparente Transparent
	 Vintage Vintage

Code	Ø mm
557216-VT	125
557217-VT	95

Sorgente Source	
Potenza Total power	5W
Temperatura di colore Color temperature	3000K
Flusso luminoso Lighting output	550Lm
Lunghezza cavi L. max Cable lenght L. max	900mm

   S+L
220-240V 50/60Hz

Pendelglobo Vintage

Color	Diffusor
 Oro Gold	 Trasparente Transparent
	 Vintage Vintage

Code	Ø mm
555349.KIT	125
555349/S.KIT	95

Sorgente Source	
Potenza Total power	5W
Temperatura di colore Color temperature	3000K
Flusso luminoso Lighting output	550Lm
Lunghezza cavi L. max Cable lenght L. max	900mm

   S+L
220-240V 50/60Hz

LED Zero - Mario

LED Zero con accessorio ROS/TON/4/B
Zero LED with ROS/TON/4/B accessory



LED
inside



LED
inside

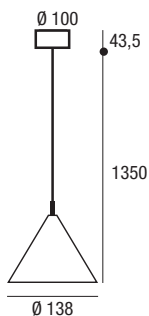

LED ZERO 20

□ SL374/WH

Sorgente Source **LED**
Potenza Total power 20W
Temperatura di colore Color temperature 3000K
Flusso luminoso Lighting output 1400Lm
Lunghezza cavi L. max Cable lenght L. max 1000 mm

CE IK07 IP20 CELL

220-240V 50/60Hz

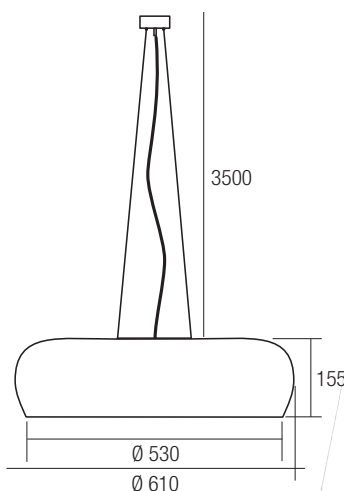

↑ Regolabile in altezza
↓ Height adjustable

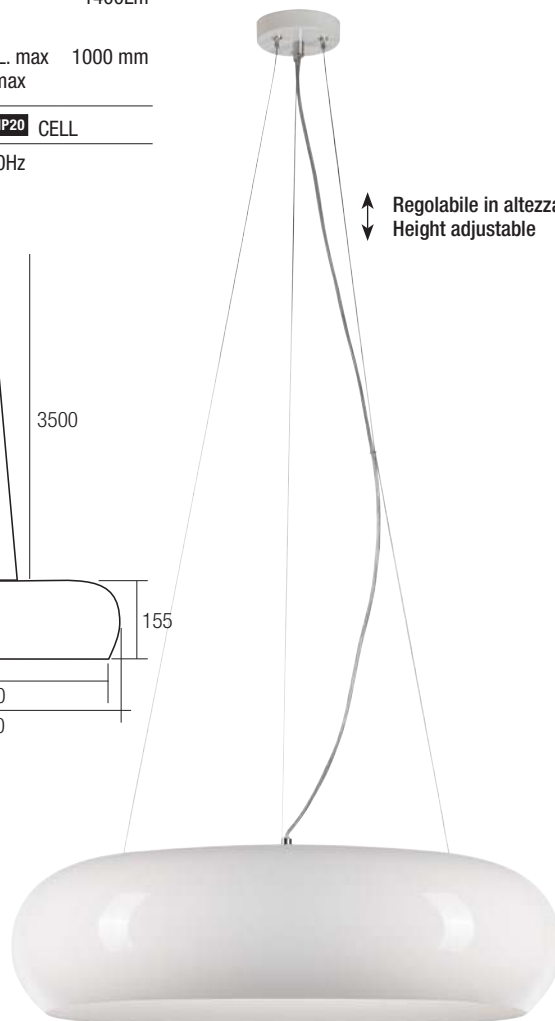

not included

MARIO - PMMA

Color Diffusor

□ Bianco White □ Plexiglass bianco White plexiglass

Code

260004

Sorgente Source **E27**

Lunghezza cavi L. max Cable lenght L. max 3500 mm

CE IK07 IP20 S

220-240V 50/60Hz

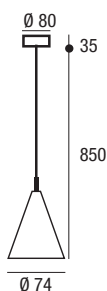

LED ZERO 5

□ SL372/WH

■ SL372/BL

Sorgente Source **LED**
Potenza Total power 5W
Temperatura di colore Color temperature 3000K
Flusso luminoso Lighting output 850Lm
Lunghezza cavi L. max Cable lenght L. max 1000 mm

CE IK07 IP20 CELL

220-240V 50/60Hz

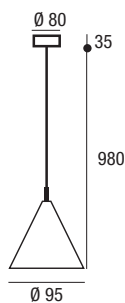

LED ZERO 10

□ SL373/WH

■ SL373/BL

Sorgente Source **LED**
Potenza Total power 10W
Temperatura di colore Color temperature 3000K
Flusso luminoso Lighting output 1200Lm
Lunghezza cavi L. max Cable lenght L. max 1000 mm

CE IK07 IP20 CELL

220-240V 50/60Hz

Geranio 3S - Geranio 7S Ciclamino S



LED
inside



LED
inside



LED
inside

Geranio 3 S

Color

 Oro
Gold

Diffusor

 Opale
Opal

Code

R-9078-3

Sorgente
Source

 15W **LED**

   CELL

Geranio 7 S

Color

 Oro
Gold

Diffusor

 Opale
Opal

Code

R-9078-7

Sorgente
Source

 35W **LED**





   CELL





Glicine S



Non incluso
Not included



Glicine S
Color Cromo Chrome
Diffusor Trasparente Transparent
Code R-9098-14CL
Sorgente Source  **12X G9**
    S

Glicine S
Color Cromo Chrome
Diffusor Fumè Smoked
Code R-9098-14FUME
Sorgente Source  **12X G9**
    S

Sospensioni - Suspension

Idee luce · Decorativo  segno

Agave C - Diphylleia S Orchidea S



Non incluso
Not included

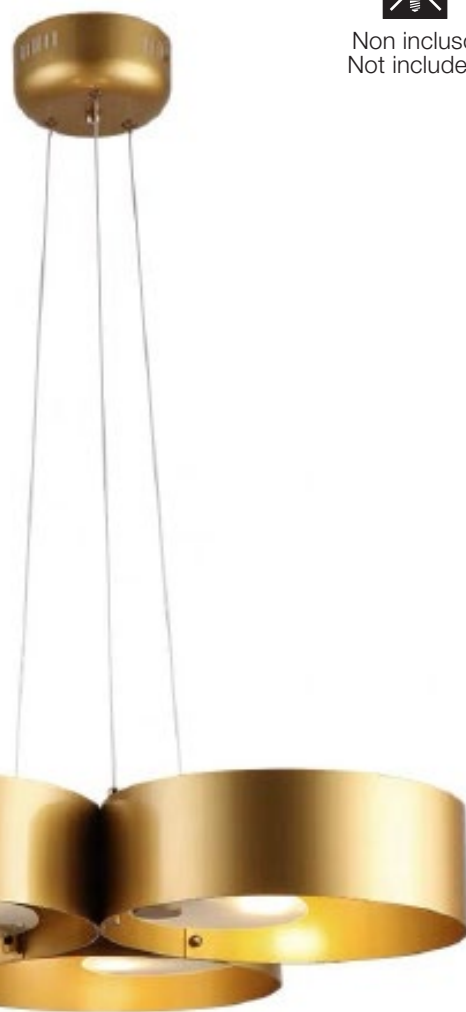
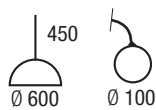

agave C

Color



Diffusor



Code

R-9067-6

Sorgente

Source



6X
G9

6X
G9

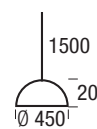
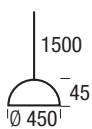

Orchidea S

Color



Diffusor



Code

R-9330

Sorgente

Source



1X
E27



Diphylleia S

Color



Diffusor



Code

R-9317

Sorgente

Source



3X
G9



Ibisco S - Lilla S Calla S



Non incluso
Not included

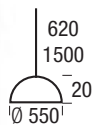

Ibisco S
Color Cromo Chrome Diffusor Bianco White
Code R-9435
Sorgente **1X E27**
CE IK07 IP20 S

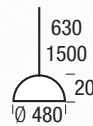

Lilla S
Color Cromo Chrome Diffusor Opale Opal
Code R-9433
Sorgente **4X E27**
CE IK07 IP20 S

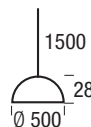

Calla S
Color Nero Black Diffusor Nero Black
Code R-9336
Sorgente **4X E27**
CE IK07 IP20 S

Gerbera S - Lavanda S Hemisphere S



Non incluso
Not included

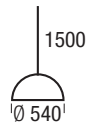
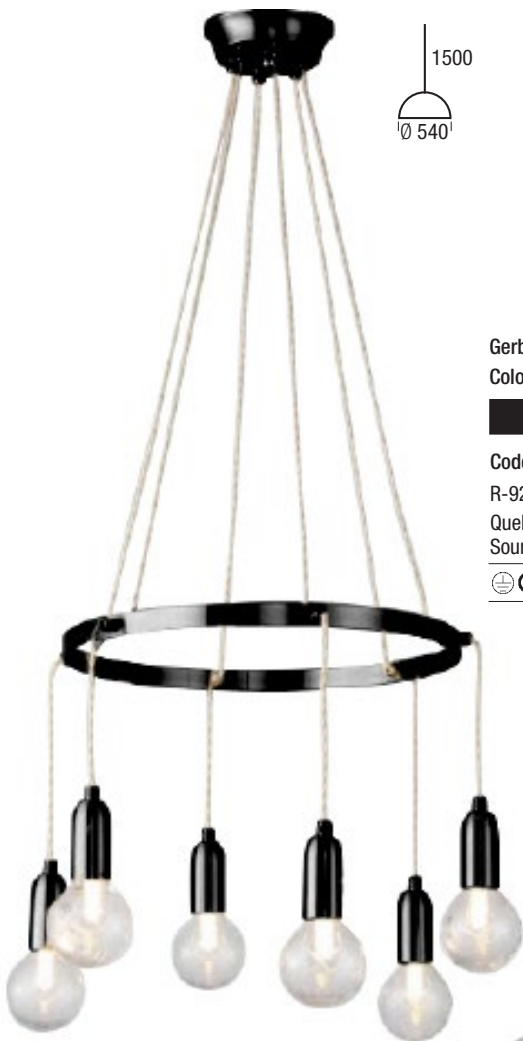

Gerbera S
Color
■ Nero
Black
□ Opale
Opal

Code
R-9280-6BK
Quelle
Source **6X**
E27
Ⓢ CE IK07 IP20 S

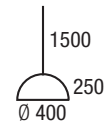
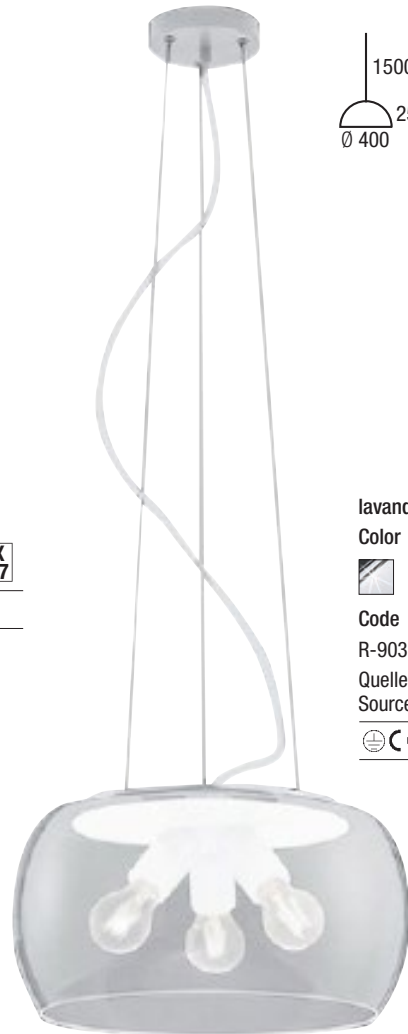

lavanda S
Color
■ Cromo
Chrome □ Trasparente
Transparent

Code
R-9032PWH
Quelle
Source **3X**
E27
Ⓢ CE IK07 IP20 S

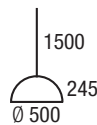

Hemisphere S
Color
□ Opale
Opal □ Opale
Opal

Code
R-SD9652-W
Quelle
Source **1X**
E27
Ⓢ CE IK07 IP20 S

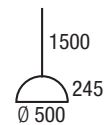

Hemisphere S
Color
■ Nero
Black □ Nero
Black

Code
R-SD9652-B
Quelle
Source **1X**
E27
Ⓢ CE IK07 IP20 S

Girasole



Colore disponibile di serie
Color available as standard



Nero
Black

Colore a richiesta
Color on request



Bianco
White

Girasole plafone



Non incluso
Not included

Una curva caratterizza questa serie di lampade in coordinato a plafone, parete, piantha e tavolo, prodotte in metallo dallo stile industrial chic disponibili nella finitura nero. Sorgenti luminose non comprese.

A curve characterizes this series of coordinated ceiling, wall, floor and table lamps, produced in metal with an industrial chic style available in a black finish. Light sources not included.

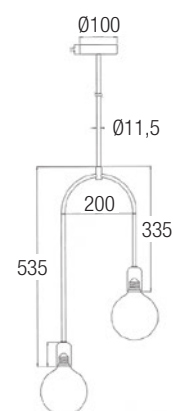
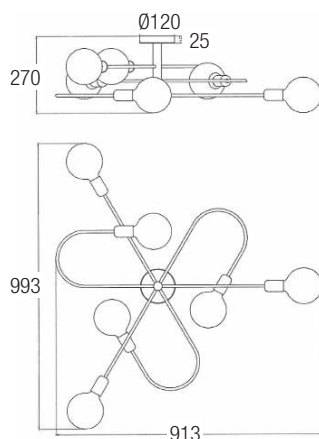
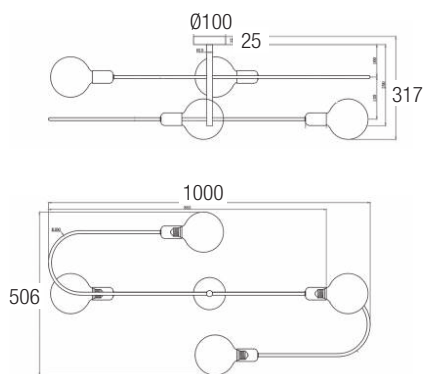

Girasole Plafone 4

Color

 Nero
Black

Code

R-SD9651-C4

Sorgente
Source



    S

220-240V 50/60Hz

Girasole Plafone 6

Color

 Nero
Black

Code

R-SD9651-C6

Sorgente
Source



    S

220-240V 50/60Hz

Girasole Plafone 2

Color

 Nero
Black

Code

R-SD9651-S2

Sorgente
Source



    S

220-240V 50/60Hz



Girasole piantana, tavolo, applique



Non incluso
Not included

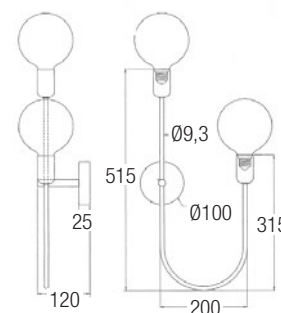
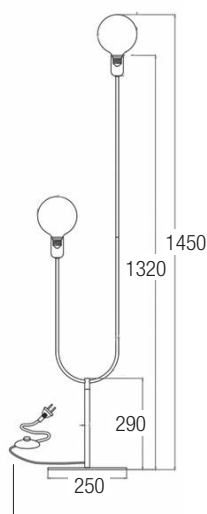
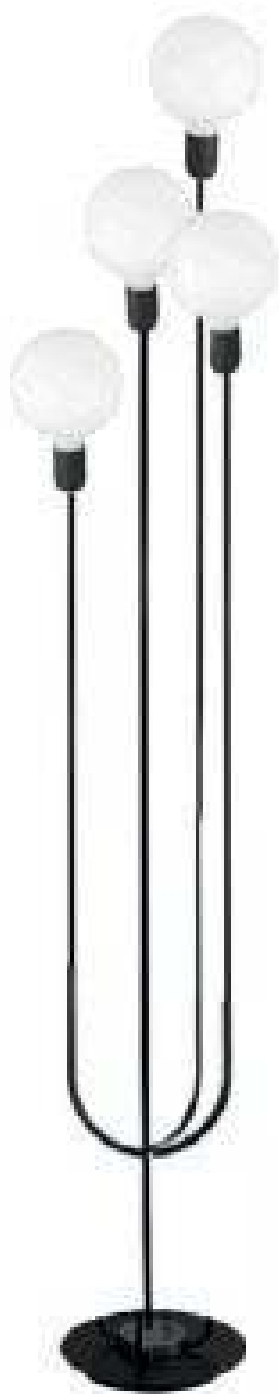

Girasole Piantana 4

Color

■ Nero
Black

Code

R-SD9651-F4

Sorgente
Source



4X
E27

CE IK07 IP20 S

220-240V 50/60Hz

Girasole Tavolo 2

Color

■ Nero
Black

Code

R-SD9651-T2

Sorgente
Source



2X
E27

CE IK07 IP20 S

220-240V 50/60Hz

Girasole Applique 2

Color

■ Nero
Black

Code

R-SD9651-W2

Sorgente
Source



2X
E27

CE IK07 IP20 S

220-240V 50/60Hz

Anthurium LED

Flex applique

Lisianthus W



Nicht enthalten
Non inclus

Applique da parete, con braccio snodato e direzionale.
Lampade da interni, ideali come testaletto e per creare
effetti luminosi decorativi.
Corpo in acciaio cromato, sorgente luminosa LED com-
presa, sorgente per portalamпада E27 non compresa.

Wall applique, with articulated and directional arm.
Indoor lamps, ideal as a bed headboard and to create
decorative lighting effects.
Body in chromed steel, LED light source included,
source for E27 lamp holder not included.

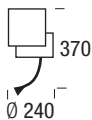
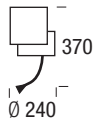

Anthurium WB LED

Color Diffusor
Cromo Chrome Nero Black

Code
R-SD9463WABK

Sorgente Source 3W

Sorgente Source 1X E27

CELL+S

Anthurium WW LED

Color Diffusor
Cromo Chrome Bianco White

Code
R-SD9463WAWH

Sorgente Source 3W

Sorgente Source 1X E27

CELL+S



FLEX applique Black

Color Code
Nero Black 9768

Sorgente Source

Lunghezza stelo L. max stem length L. max 510 mm

S

220-240V 50/60Hz

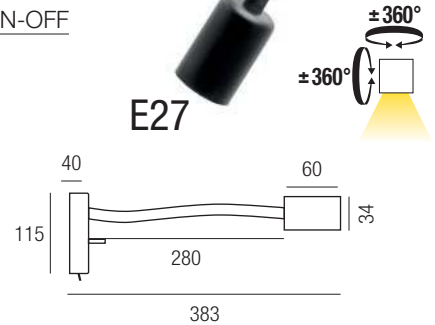

Faretto da parete orientabile, con braccio snodato e direzionale.
Lampade da interni, ideali come testaletto e per creare effetti luminosi deco-
rativi. Corpo in acciaio verniciato con tubo protettivo plastico nero, sorgente
luminosa non compresa.

Adjustable wall spotlight, with articulated and di-rectable arm.
Indoor lamps, ideal for headboards and for creating decorative light effects.
LED source and power supply included, with switch. Body in painted steel with
protec-tive black plastic tube, light source not included.

Applique da parete da interni,
ideali per le zone umide. Cor-
po in acciaio cromato. Sorgen-
te per portalamпада E27 non
compresa.

Interior wall wall light, ideal for
wetlands. Chromed steel body.
Source for E27 lamp holder not
included.

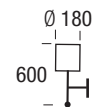

Lisianthus W

Color Diffusor
Cromo Chrome Bianco White

Code
R-9434W

Sorgente Source 1X E27

S

Giacinto - Ego - Baby



Non incluso
Not included



Giacinto

Color	Code
Bianco White	4010/50/N
Nero Black	4010/50/NN
Grigio Grey	4010/50/NG

Sorgente
Source Non inclusa
Not included

**2X
R7S**

IK07 IP20 S

Per i colori Nero e Grigio tempo di consegna 30gg.
For Black and Gray colors delivery time 30 days.

220-240V 50/60Hz

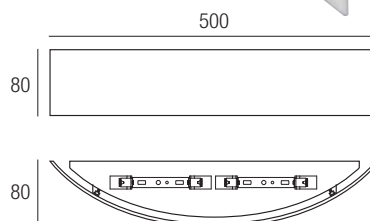

Appliche e plafoniere - Wall and ceiling



Ego 15

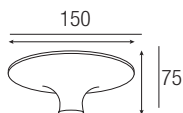

Ego 25

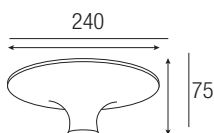

Ego 15

Color
Bianco White

Code	Euro cad.
32200 Ego 15	15,00

Sorgente
Source **E27**

IK07 IP20 S
220-240V 50/60Hz

Ego 25

Color
Bianco White
G Grigio Grey

Code	Euro cad.
32210 Ego 25	25,00
32211 G Ego 25	25,00

Sorgente
Source **E27**

IK07 IP20 S
220-240V 50/60Hz

Lampade da soffitto e da parete, semplici e moderne, dal design piacevole. Emettono una luce diffusa e sono adatte ad ambienti domestici e per illuminare corridoi e sale di attesa. Sorgenti luminose non comprese.

Ceiling and wall lamps, simple and modern, with a pleasant design. They emit a diffused light and are suitable for domestic environments and for illuminating corridors and waiting rooms. Light sources not included.



Baby

Color	Cod.
Cromo Chrome	150004
Oro Gold	150005
Rame Copper	150006

Sorgente
Source **E27**

IK07 IP20 S
220-240V 50/60Hz

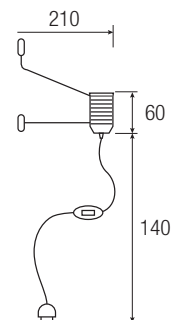

Jodie S - Glass



Non incluso
Not included



Sospensioni in vetro per luce diffusa adatto per applicazioni da interno con diffusore in vetro incamiciato bianco opale, rosone e aggancio lampada cromato, cavo trasparente, per installazioni singole o multiple tramite l'utilizzo dei rosone multi lampada da ordinare separatamente.
Sorgenti luminose non comprese.

Glass suspensions for diffused light for indoor applications with opal white cased glass diffuser, chrome ceiling rose and lamp coupling, transparent cable, for single or multiple installations using multi-lamp ceiling rose to be ordered separately.
Light sources not included.

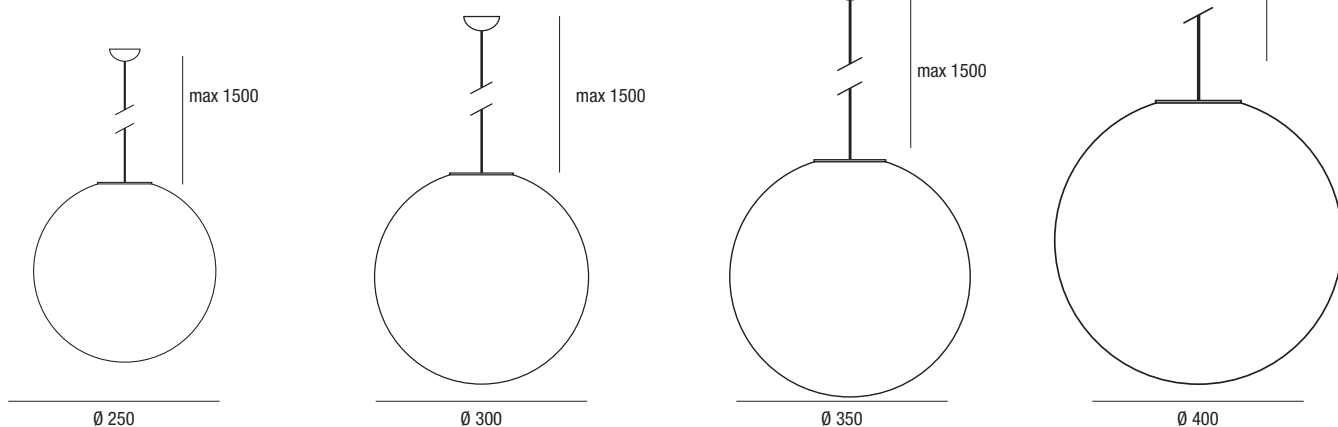

Jodie S25

Color diffusor
 Cromo Vetro bianco opale
 Chrome Opal white glass

Code
R-GY3125CW

Sorgente
 Source **E27**

 220-240V 50/60Hz

Jodie S30

Color diffusor
 Cromo Vetro bianco opale
 Chrome Opal white glass

Code
R-GY3130CW

Sorgente
 Source **E27**

 220-240V 50/60Hz

Jodie S35

Color diffusor
 Cromo Vetro bianco opale
 Chrome Opal white glass

Code
R-GY3135CW

Sorgente
 Source **E27**

 220-240V 50/60Hz

Jodie S40

Color diffusor
 Cromo Vetro bianco opale
 Chrome Opal white glass

Code
R-GY3140CW

Sorgente
 Source **E27**

 220-240V 50/60Hz

KIT multi lampada per Jodie S

Scelta diffusori | *Diffuser choice*



Dispositivo meccanico per la sospensione multipla, consente di sospendere tre o cinque apparecchi di illuminazione della serie Jodie S.

E' composto da un'attacco meccanico a plafone dotato di serracavi, doppi morsetti di connessione alla rete di alimentazione elettrica per accensioni separate ed una copertura in metallo verniciato.

Non può essere utilizzato per la serie: JERI S - Murano

Mechanical device for multiple suspension, allows you to suspend three or five lighting fixtures from the Jodie S series.

It consists of a mechanical ceiling attachment equipped with cable clamps, double terminals for connection to the mains power supply for separate switching on and a painted metal cover.

Cannot be used for series: JERI S - Murano

Serie Jodie S



Jodie S25 - Ø250mm

Codice *Code*

R-GY3125CW

Peso *Weight*

1 Kg



Jodie S30 - Ø300mm

Codice *Code*

R-GY3130CW

Peso *Weight*

2 Kg



Jodie S35 - - Ø350mm

Codice *Code*

R-GY3135CW

Peso *Weight*

2,5 Kg



Jodie S40 - - Ø400mm

Codice *Code*

R-GY3140CW

Peso *Weight*

3 Kg

Tasselli e viti non compresi. Per l'installazione a soffitto utilizzare tasselli e viti adeguati al peso totale della lampada e alla superficie su cui andrà ancorata.

Plug and screws are not included. Ceiling installation use plug and screws adapted to the total weight of the lamp and the surface on which will be anchored.

Esempi di installazione per Jodie S Ø250, Ø300 e Ø350
 Example of installation for Jodie S Ø250, Ø300 and Ø350

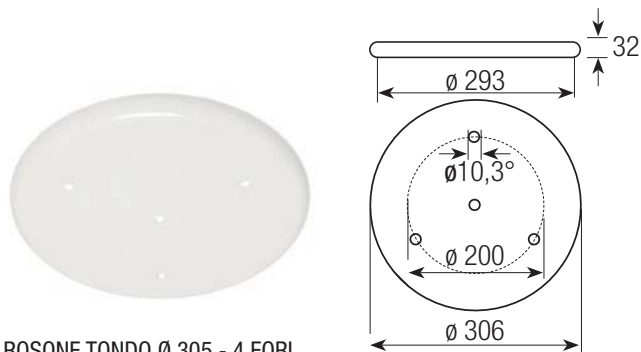
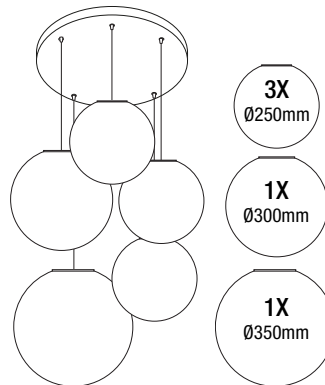
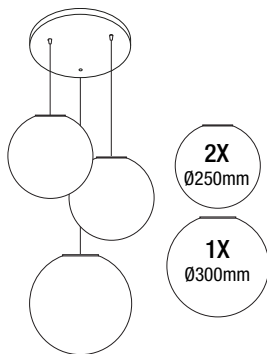

ROSONE TONDO Ø 305 - 4 FORI
 ROUND CEILING ROSE Ø 305 - 4 HOLES

Color Code
 Bianco White ROS/TON/4/B

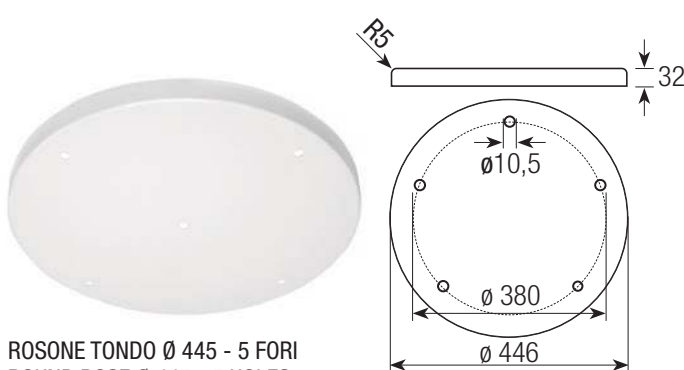

ROSONE TONDO Ø 445 - 5 FORI
 ROUND ROSE Ø 445 - 5 HOLES

Color Code
 Bianco White ROS/TON/5/B

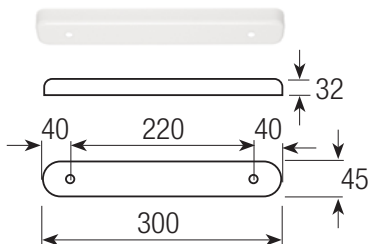
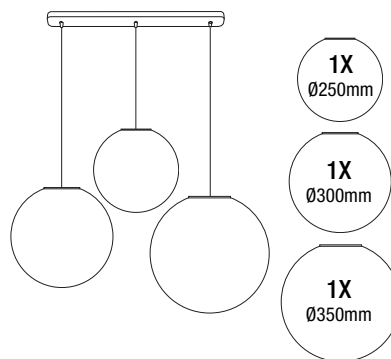
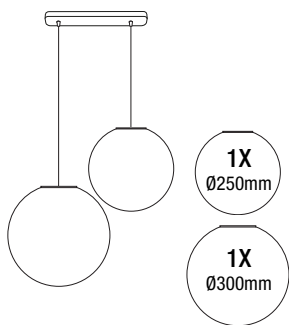

ROSONE RETTANGOLARE 2 FORI
 2-HOLE RECTANGULAR CEILING ROSE

Color Code
 Bianco White ROS/RET/2/B

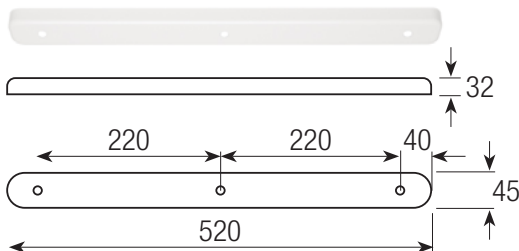

ROSONE RETTANGOLARE 3 FORI
 3-HOLE RECTANGULAR CEILING ROSE

Color Code
 Bianco White ROS/RET/3/B

Vetro palla S

Vetro/Glass



Non incluso
Not included

Sospensioni in vetro per una luce diffusa per applicazioni da interno con diffusore in vetro trasparente, Ambra, cromo scuro, azzurrato e fumè rigato e rosone in tinta e cavo intrecciato. Sorgenti luminose non comprese.

Glass suspensions for diffused light for indoor applications with diffuser in transparent, amber, dark chrome, blued and striped smoked glass and matching rosette and braided cable. Light sources not included.

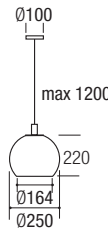
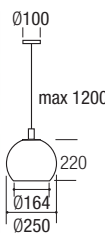
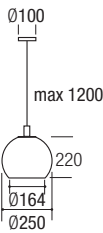
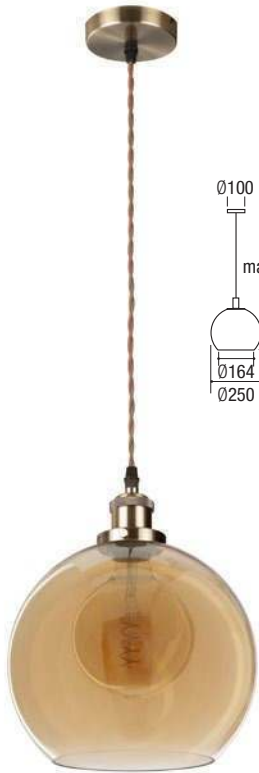

Vetro palla Dark Crome

Color Nero Black Diffusor Cromo scuro Dark Chrome

Code
R-GY3104SM

Sorgente Source **1X E27**

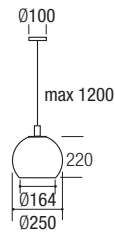
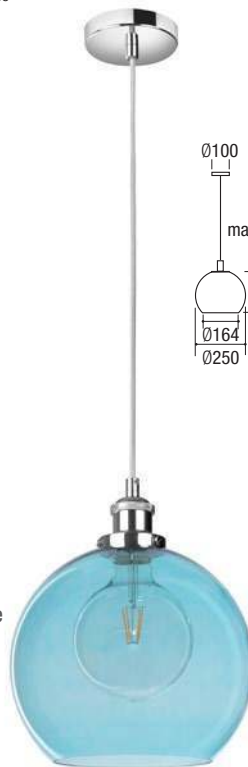

Vetro palla Sky blu

Color Cromo Chrome Diffusor Azzurro Sky blu

Code
R-GY3104LB

Sorgente Source **1X E27**

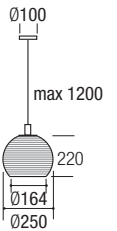
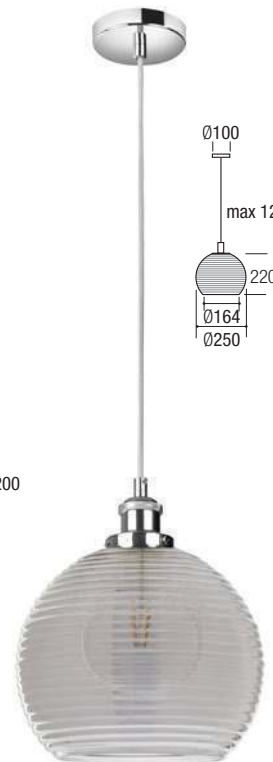

Vetro palla Fumè rigato

Color Cromo Chrome Diffusor Fumè Smoked

Code
R-GY3152SM

Sorgente Source **1X E27**



Vetro palla Ambra

Color Rame Copper Diffusor Ambra Amber

Code
R-GY3104AM

Sorgente Source **1X E27**



Vetro palla Trasparente

Color Cromo Chrome Diffusor Trasparente Transparent

Code
R-GY3104PTL

Sorgente Source **1X E27**



Vittoria, Fatua



OGGETTO REALIZZATO
CON VETRO
PRODOTTO A
MURANO
MADE IN ITALY



Vittoria



Fatua



Non incluso
Not included



Vittoria

Color	diffusor
<input type="checkbox"/> Bianco White	<input type="checkbox"/> Vetro opale Opal glass

Code	Ø L
51304550	320
51304750	450

Sorgente
Source

	1X E14	1X E27
--	--------	--------

Vittoria 2 Ø 320 - 1x E14+1E27
Vittoria 1 Ø 450 - 5x E27

Potenza Total power	E14 - max 40W E27 - max 60W
------------------------	--------------------------------

220-240V 50/60Hz

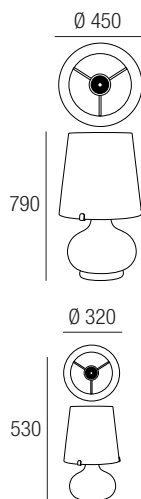

Fatua 1000 COLORS

Color	diffusor
<input checked="" type="checkbox"/> Vetro trasparente Transparent glass	<input type="checkbox"/> Vetro opale Opal glass

Code
820002

Sorgente
Source **LED**
Potenza
Total power 21W
Temperatura di colore
Color temperature **RGB**
Flusso luminoso
Lighting output 240Lm

220-240V 50/60Hz

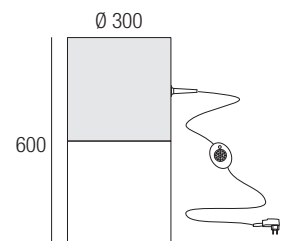

Jeri S

OGGETTO REALIZZATO
CON VETRO
PRODOTTO A
MURANO
MADE IN ITALY



Non incluso
Not included



Apparecchi di illuminazione ad applique per una luce diffusa per applicazioni da interno con diffusore in vetro incamiciato bianco opale prodotto mediante lo storico processo produttivo veneziano di soffiatura a bocca e molatura manuale. La manutenzione ordinaria dell'apparecchio è garantita da un dispositivo meccanico di sgancio del diffusore stesso dalla montatura elettrica. Sorgenti luminose non comprese.

Wall lighting appliances for a diffused light for interior applications with diffuser made of opal white encased glass produced using the historical Venetian process of glass blowing and manual grind-ing.

Routine maintenance of the appliance is guaranteed by a mechanical release device of the diffuser from the electric fitting.

Light sources not included.

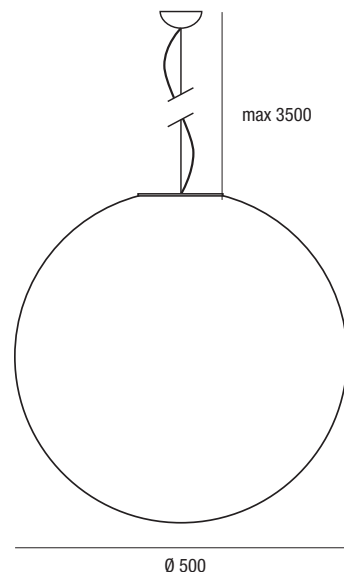
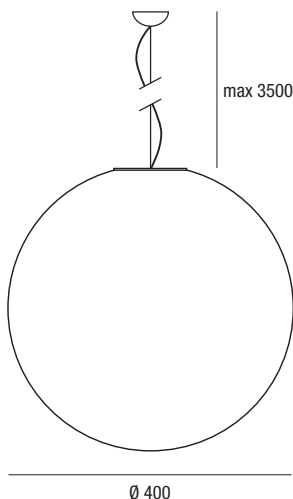
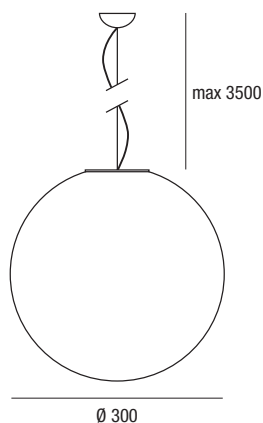

Jery S2

Color diffusor
 Bianco White
 Vetro bianco opale Opal white glass

Code

646/S2

Sorgente Source  **E27**

220-240V 50/60Hz

Jery S1

Color diffusor
 Bianco White
 Vetro bianco opale Opal white glass

Code

646/S1

Sorgente Source  **E27**

220-240V 50/60Hz

Jery S3

Color diffusor
 Bianco White
 Vetro bianco opale Opal white glass

Code

646/S3

Sorgente Source  **E27**

220-240V 50/60Hz



Aki, Cupo



Non incluso
Not included

OGGETTO REALIZZATO
CON VETRO
PRODOTTO A
MURANO
MADE IN ITALY

Applique per una luce diffusa per applicazioni da interno con vetro soffiato triplex lucido e satinato con parti metalliche laccate bianche, prodotto mediante lo storico processo produttivo veneziano di soffiatura a bocca e molatura manuale, il diffusore è lavorato artigianalmente mediante un sofisticato processo di ricottura e formatura ad alta temperatura.

Sorgenti luminose non comprese.

Wall lamp for diffused light for indoor applications with glossy and satin triplex blown glass with white lacquered metal parts, produced through the historic Venetian production process of mouth blowing and manual grinding, the diffuser is handcrafted through a sophisticated annealing and forming process at high temperature.

Light sources not included.

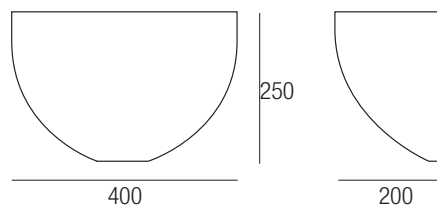
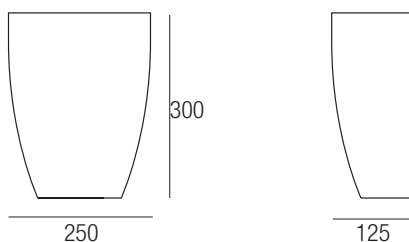

Aki

Color diffusor

- Bianco White Vetro bianco opale Opal white glass

Code

APAKI300BCS

Sorgente
Source



CE IK07 IP20 S

220-240V 50/60Hz

Cupo

Color diffusor

- Bianco White Vetro bianco opale Opal white glass

Code

APCUP0400BCS

Sorgente
Source



CE IK07 IP20 S

220-240V 50/60Hz

Font, Milu

OBJECT MADE
WITH GLASS
PRODUCT A
MURANO
MADE IN ITALY



Non incluso
Not included

Applique per una luce diffusa per applicazioni da interno con vetro soffiato triplex lucido e satinato con parti metalliche laccate bianche, prodotto mediante lo storico processo produttivo veneziano di soffiatura a bocca e molatura manuale, il diffusore è lavorato artigianalmente mediante un sofisticato processo di ricottura e formatura ad alta temperatura.

Sorgenti luminose non comprese.

Wall lamp for diffused light for indoor applications with glossy and satin triplex blown glass with white lacquered metal parts, produced through the historic Venetian production process of mouth blowing and manual grinding, the diffuser is handcrafted through a sophisticated annealing and forming process at high temperature.

Light sources not included.

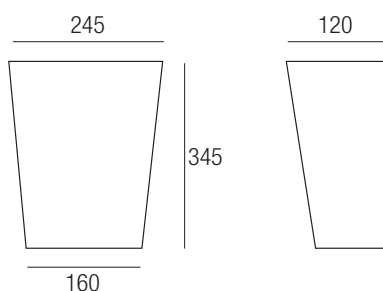

Font

Color diffusor

- Bianco White
- Vetro bianco opale Opal white glass

Code

APFONT340BCS

Sorgente Source  

    S

220-240V 50/60Hz

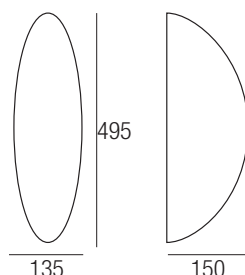

Milu

Color diffusor

- Bianco White
- Vetro bianco opale Opal white glass

Code

APMILU500BCS

Sorgente Source  

    S

220-240V 50/60Hz

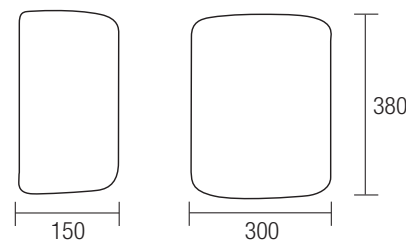

ARIETE Quadro

Color diffusor

- Bianco White
- Vetro bianco opale Opal white glass

Code

APLND300BCS

Sorgente Source  

    S

220-240V 50/60Hz

Ariete tondo



Non incluso
Not included



Serie di Lampade a plafone o parete, caratterizzate da una forma morbida e piacevole e con un'ottima diffusione della luce grazie al diffusore in vetro soffiato bianco, con attacco E27 singolo per ARIETE 250 e ARIETE MEZZA SFERA o con attacco E27 doppio per le altre versioni è possibile equipaggiarle di sorgente luminosa a LED (non compresa).

Series of ceiling or wall lamps, featuring a soft and pleasant shape and excellent light diffusion thanks to the white blown glass shade, with single E27 socket for ARIETE 250 and ARIETE MEZZA SFERA or with double E27 holder for the other versions, they may be fitted with LED light source (not included).

Appique e plafoniere moderne - Modern wall and ceiling

Idee luce - Decorativo - segno

OGGETTO REALIZZATO
CON VETRO
PRODOTTO A
MURANO
MADE IN ITALY

OGGETTO REALIZZATO
CON VETRO
PRODOTTO A
MURANO
MADE IN ITALY

OGGETTO REALIZZATO
CON VETRO
PRODOTTO A
MURANO
MADE IN ITALY

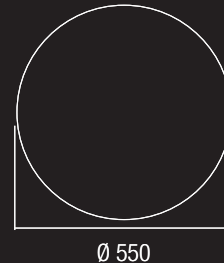
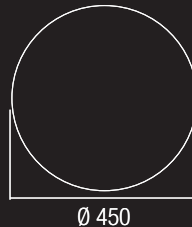
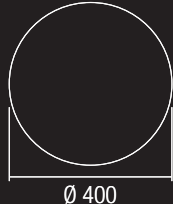
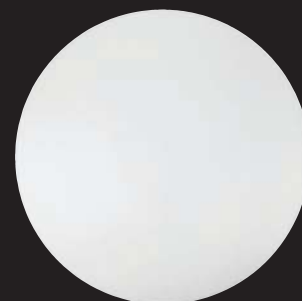

ARIETE 250 - S

B PLPOL250BCS

O Diffusore vetro opale
Diffusor opal glass

Sorgente
Source



2X
E27



220-240V 50/60Hz

ARIETE 355 - S

B PLLW400BCS

O Diffusore vetro opale
Diffusor opal glass

Sorgente
Source



2X
E27



220-240V 50/60Hz

ARIETE 450 - S

B D63614

O Diffusore vetro opale
Diffusor opal glass

Sorgente
Source



2X
E27



220-240V 50/60Hz

ARIETE 550 - S

B PLLW550BCS

O Diffusore vetro opale
Diffusor opal glass

Sorgente
Source



3X
E27



220-240V 50/60Hz



Sovraspecchio LED IP54

Over mirror lamps



Appliche in alluminio verniciato bianco o argento con schermo in policarbonato opale, IP54 con illuminazione a LED integrata 3CCT con possibilità di scelta tra tre diverse temperature di colore, bianco caldo, bianco neutro o bianco freddo, idonea per applicazioni in zone umide, utilizzo ideale come lampada sopra-specchio in bagno oppure per illuminare quadri.

Aluminium wall lamp painted white or silver plated with opal polycarbonate screen, IP54 with integrated LED illumination 3CCT with possibility of choice of three different color temperatures, warm white, neutral white or cool white, suitable for applications in humid areas, ideal for use as a light above the bathroom mirror or to light up pictures.

3 in 1

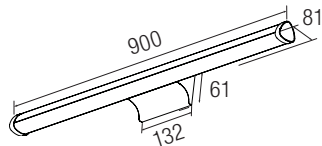
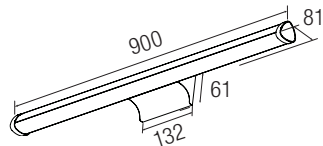
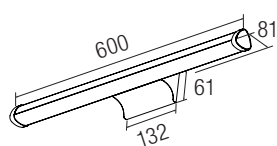
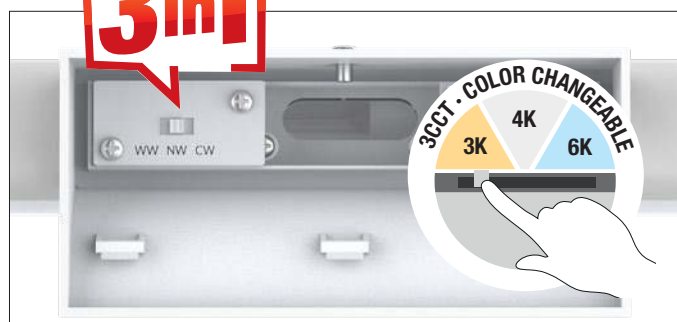

Sovraspecchio 10W



Color	Diffusor
<input type="checkbox"/> Bianco White	<input type="checkbox"/> PC Bianco White PC

Code	R-600B10W		
Sorgente Source	LED		
Potenza Total power	10W		
Temperatura di colore Color temperature	3CCT		
	K	Lm	
Flusso luminoso Lighting output	3000	1148	
	4000	1180	
	6000	1143	
Angolo fascio luminoso Beam angle	110°		
110-240V 50/60Hz			

Sovraspecchio 15W



Color	Diffusor
<input type="checkbox"/> Bianco White	<input type="checkbox"/> PC Bianco White PC

Code	R-900B-15W		
Sorgente Source	LED		
Potenza Total power	15W		
Temperatura di colore Color temperature	3CCT		
	K	Lm	
Flusso luminoso Lighting output	3000	1800	
	4000	1842	
	6000	1790	
Angolo fascio luminoso Beam angle	110°		
110-240V			

Sovraspecchio 15W



Color	Diffusor
<input checked="" type="checkbox"/> Argento Silver	<input type="checkbox"/> PC Bianco White PC

Code	R-900S-15W		
Sorgente Source	LED		
Potenza Total power	15W		
Temperatura di colore Color temperature	3CCT		
	K	Lm	
Flusso luminoso Lighting output	3000	1800	
	4000	1842	
	6000	1790	
Angolo fascio luminoso Beam angle	110°		
110-240V 50/60Hz			

Specchio LED

Mirror lamps



Serie di specchi con lampada a LED incorporata in IP44, retroilluminati con banda sabbiata, accensione e spegnimento tramite pulsante sensoriale a sfioro posto sulla parte frontale dello specchio. Idonea per applicazioni in zone umide.

Corredato di supporti per il fissaggio, alimentatore posizionato all'interno della struttura e sorgente LED.

Series of mirrors with built-in IP44 LED lamp, backlit with sandblasted band, switching on and off by means of a sensory touch button on the front mirror doors. Suitable for applications in wet areas.

Equipped with supports for fixing, power supply positioned inside the structure and LED source.

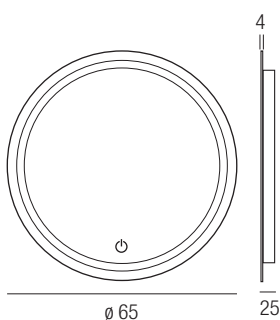

Specchio LED ø 65

Color	Diffusor
Specchio Mirror	Vetro satinato satin Glass

Cod.	
M600	3000K
Sorgente Source	
Potenza Total power	15W
Temperatura di colore Color temperature	3000K
Flusso luminoso Lighting output	800Lm

CELL

220-240V 50/60Hz

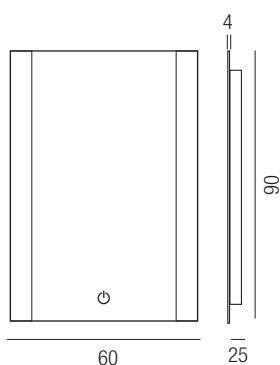

Specchio LED Verticale

Color	Diffusor
Specchio Mirror	Vetro satinato satin Glass

Cod.	
M401	3000K
Sorgente Source	
Potenza Total power	15W
Temperatura di colore Color temperature	3000K
Flusso luminoso Lighting output	800Lm

CELL

220-240V 50/60Hz

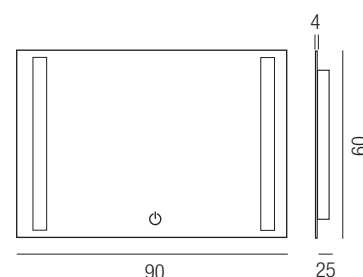

Specchio LED Orizzontale

Color	Diffusor
Specchio Mirror	Vetro satinato satin Glass

Cod.	
M406	3000K
Sorgente Source	
Potenza Total power	15W
Temperatura di colore Color temperature	3000K
Flusso luminoso Lighting output	800Lm

CELL

220-240V 50/60Hz

Buddleja T, Gerbera F Nandina F, Lavanda T



Non incluso
Not included



400
Ø 190

Buddleja T

Color	Diffusor	Code
Cromo Chrome	Bianco White	R-SD9456TCH
Rame Copper	Bianco White	R-SD9456TCOPP

Sorgente
Source **1X E27**

S

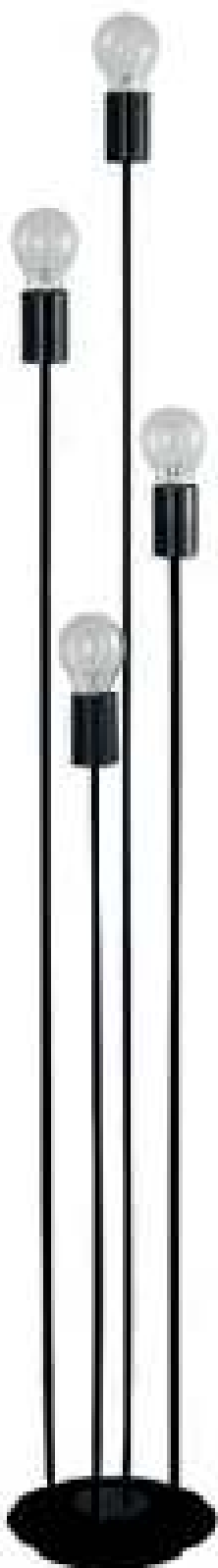

Ø 250
1500

Gerbera F

Color	Diffusor
Nero Black	Opale Opal

Code

R-9264FBK

Sorgente
Source **4X E27**

Potenza
Total power max60W

S

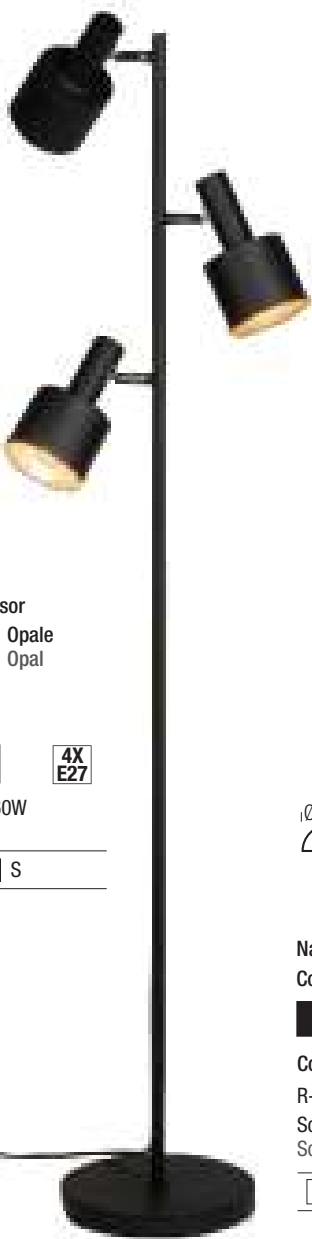

Ø 380
1600

Nandina F

Color	Diffusor
Nero Black	Nero Black

Code

R-9474F

Sorgente
Source **3X E14**

S



Ø 300
450

lavanda T

Color	Diffusor	Code
Bianco White	Bianco White	R-9305TWH
Nero Black	Nero Black	R-9305TBK

Sorgente
Source **2X E27**

S

Smart LED



LED
inside

Smart Led, corpo in alluminio, ABS.

- Porta USB per ricaricare i telefoni cellulari
- Interruttore tattile con funzione dimmer
- temperatura colore 4000K

Smart Led, body in aluminium, ABS.

- USB port to charge mobile phones
- Touch switch with dimming function
- colour temperature 4000K



Smart LED

Color **Code**

 Nero
Black 8358

Sorgente 
Source

Potenza 8W
Total power

Temperatura di colore 3000K/6000K
Color temperature

Flusso luminoso 400Lm
Lighting output

220-240V 50/60Hz DRIVER INCLUDED

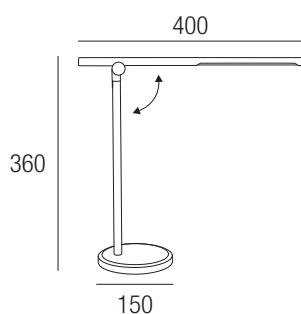

Serie LED Battery

*Senza fili, la porti...
..ovunque vuoi tu!*

**Accessorio a richiesta:
adattatore USB a 10 porte**
**Accessory on request:
10 port USB adapter**

Input: AC 100-240V
Output: 50/60Hz DC 5V 8A (max.)
Cable length: 120cm
Cod. USB10P

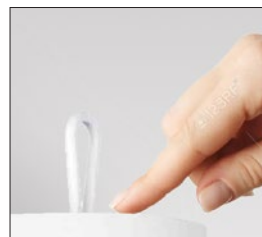

Portatile non necessita di prese di corrente grazie alla batteria ricaricabile può essere messa ovunque tu decida, con luce soft per momenti rilassanti, ottime per ambienti all'aperto, terrazzi o giardini, grazie all'alto grado IP.

Portable and rechargeable, it can be placed wherever you decide, with soft light for relaxing moments, excellent for outdoor environments, terraces or gardens thanks to the high IP rating.

- Portatile e ricaricabile
- 1 metro di cavo USB
- Dimmerabile
- 7 ore di luce senza fili
- Ideale per indoor e outdoor
- Luce calda e soft
- *Portable and rechargeable*
- *1 meter of USB cable*
- *Dimmable*
- *7 hours of wireless light*
- *Ideal for indoor and outdoor*
- *Warm and soft light*



Ø110



Ø80



380

Ø100

LED Po IP54

Color

- Bianco White
- Nero Black
- Grigio Grey

Code

- PO-W-3W
- PO-BK-3W
- PO-GR-3W

Sorgente

Source



Potenza

Total power

3W

Temperatura di colore

Color temperature

3000K

Flusso luminoso

Lighting output

136Lm



Batteria ioni di litio - Lithium-ion battery

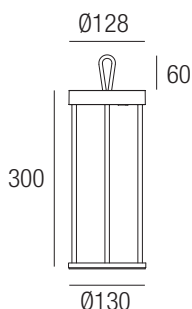

incluso
included

Gancio con cavo 60cm
Hook with cable 60cm



incluso
included

Staffa a parete
Wall bracket

LED Tevere lanterna

Color	Code
<input type="checkbox"/> Bianco White	TEVERE-W-3W

Sorgente Source	LED
Potenza Total power	3W
Temperatura di colore Color temperature	3000K
Flusso luminoso Lighting output	143Lm



Batteria ioni di litio - Lithium-ion battery

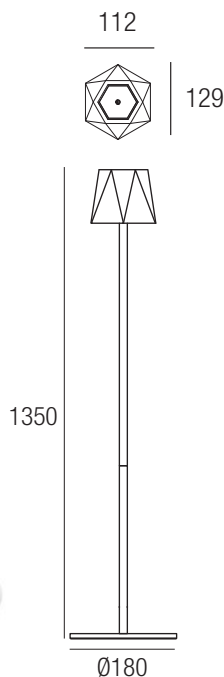

LED Reno Piantana

Color	Code
<input type="checkbox"/> Bianco White	RENO-P-W-3W

Sorgente Source	LED
Potenza Total power	3W
Temperatura di colore Color temperature	3000K
Flusso luminoso Lighting output	136Lm



Batteria ioni di litio - Lithium-ion battery

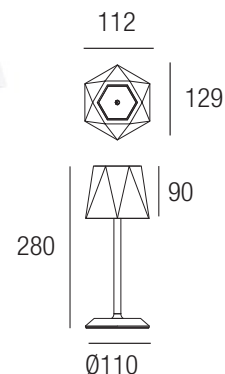

LED Reno tavolo

Color	Code
<input type="checkbox"/> Bianco White	RENO-W-3W

Sorgente Source	LED
Potenza Total power	3W
Temperatura di colore Color temperature	3000K
Flusso luminoso Lighting output	136Lm



Batteria ioni di litio - Lithium-ion battery

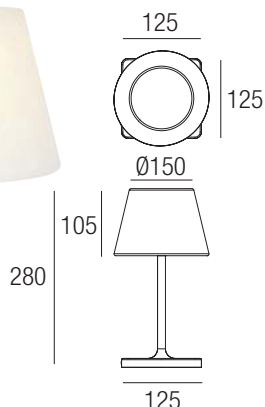

LED Piave

Color	Code
<input type="checkbox"/> Bianco White	PIAVE-W-3W

Sorgente Source	LED
Potenza Total power	2W
Temperatura di colore Color temperature	3000K
Flusso luminoso Lighting output	170Lm



A batteria - Battery



Ventilatori - Fans



Non incluso
Not included

Ventilatori a soffitto a quattro pale in legno verniciato. viene fornito di telecomando e invertitore di marcia estate-inverno, lampadina esclusa.

Four blade ceiling fans in painted wood. It is supplied with remote control and summer-winter motion inverter, lightbulb not included.



WENGHÈ 4 PALE

4561

Diffusore vetro opale
Diffusor opal glass

Quelle
Source

N° portalampada
N° lampholder 2

Attacco
Lampholder E27

Potenza motore
Total power engine 60W

Altezza
Height 410 mm

Diametro
Diameter 1220 mm

220-240V 50/60Hz



A corredo, telecomando
programmabile 1-2-4-8h.
Including programmable
remote control 1-2-4-8h.

LAMPADE LED - LED LAMPS

CONFORMI A:

- **Direttiva 2009/125/CE (Direttiva Ecodesign)**
- **Regolamento (UE) 2021/341 che garantiscono la corretta efficienza energetica e la durata**

COMPLY WITH:

- **Directive 2009/125 / EC (Ecodesign Directive)**
- **Regulation (EU) 2021/341 which guarantee the correct energy efficiency and durability**

REGOLAZIONE LAMPADE - LAMP DIMMING



Per una regolazione più sicura di lampade LED dimmerabili si consiglia l'uso dei dimmer Relco specifici per lampade LED

For a better regulation of the LED bulbs we recommend the use of the dimmer Relco for LED bulbs



LT 2 UN
Pag. 134

Regolatori da incasso per lampade LED dimmerabili
Built in dimmer for dimmable LED bulbs
Pag. 132

Promo espositore - Expositor promotion

LED

Codice espositore
Expositor code
R00012.01

Codice crowner luminoso
Light crowner code
R00005.01

Dimensioni - *Dimensions*
40x46x190cm

Contiene **max 200** lampade
Contains max 200 lamps

Sfera - Ball lamp

E14 - E27



- 1 -



- 2 -



- 3 -

Vetro - Glass

Plastica - Plastic



Astuccio con asola
Pack with slot

Fig.	W	V			K	lm	Ra ≥	DIM			H mm	Ø mm	PCS		CBM m³		EAN 8009935	Code
- 1 -	5≈(40)	220-240	E14	360°	3000	500	80	SI	15.000	25.000	75	45	10	0,0035	ASA	101624	555242	
- 1 -	5≈(40)	220-240	E27	360°	3000	500	80	SI	15.000	25.000	75	45	10	0,0035	ASA	101693	555244	
- 1 -	5≈(40)	220-240	E14	360°	6500	500	80	SI	15.000	25.000	75	45	10	0,0035	ASA	101761	555243	
- 1 -	5≈(40)	220-240	E27	360°	6500	500	80	SI	15.000	25.000	75	45	10	0,0035	ASA	101839	555245	
- 2 -	5≈(40)	220-240	E14	360°	3000	500	80	NO	15.000	25.000	75	45	10	0,0035	ASA	007414	555277.0101	
- 2 -	4≈(40)	220-240	E14	360°	4000	470	80	NO	15.000	25.000	82	45	10	0,0017	ASA	0074201	555277.4K	
- 2 -	5≈(40)	220-240	E27	360°	3000	500	80	NO	15.000	25.000	75	45	10	0,0035	ASA	101174	555281.0101	
- 3 -	4≈(60)	220-240	E27	360°	6500	600	80	NO	15.000	25.000	75	45	10	0,0035	ASA	021434	555245.0101	

Oliva - Candle

E14



- 1 -



- 2 -

Vetro / Glass



Astuccio con asola
Pack with slot

Fig.	W	V			K	lm	Ra ≥	DIM			H mm	Ø mm	PCS		CBM m³		EAN 8009935	Code
- 1 -	4≈(40)	220-240	E14	360°	3000	470	80	SI	15.000	25.000	98	35	10	0,0012	ASA	101907	555280	
- 1 -	4≈(40)	220-240	E14	360°	4000	470	80	SI	15.000	25.000	98	35	10	0,0012	ASA	010124	555280.4K	
- 2 -	5≈(40)	220-240	E14	360°	3000	500	80	NO	15.000	25.000	98	35	10	0,0056	ASA	007483	555278.0101	

Colpo di Vento - Bent-tip Candle / Tortiglione - Twisted Lamp

E14



Astuccio con asola
Pack with slot

- 1 -

- 1 -

- 3 -

- 4 -

- 5 -

Vetro - Glass

Plastica - Plastic

Vetro - Glass

Colpo di Vento - Bent-tip Candle

Fig.	W	V			K	lm	Ra ≥	DIM			H mm	Ø mm	PCS		CBM m³		EAN 8009935	Code
- 1 -	6≈(40)	220-240	E14	360°	3000	600	80	SI	15.000	25.000	131	37	10	0,0032	ASA	102041	555201	
- 1 -	6≈(40)	220-240	E14	360°	6000	600	80	SI	15.000	25.000	131	37	10	0,0032	ASA	102119	555202	
- 1 -	5≈(40)	220-240	E14	360°	3000	500	80	NO	15.000	25.000	125	35	10	0,0056	ASA	101310	555283.0101	
- 3 -	6≈(40)	220-240	E14	200°	6500	600	80	NO	15.000	25.000	131	37	10	0,0032	ASA	019745	555202.0101	

Tortiglione - Twisted Lamp

Fig.	W	V			K	lm	Ra ≥	DIM			H mm	Ø mm	PCS		CBM m³		EAN 8009935	Code
- 4 -	5≈(40)	220-240	E14	360°	3000	500	80	NO	15.000	25.000	100	35	10	0,0056	ASA	101242	555282.0101	
- 5 -	5≈(40)	220-240	E14	360°	3000	500	80	NO	15.000	25.000	100	35	10	0,0056	ASA	008183	555351.0101	

Reflector R50 - R63



Astuccio con asola
Pack with slot

- 1 -

- 2 -

- 3 -

Vetro - Glass

Plastica - Plastic

Metallo - Metal

Fig.	W	V			K	lm	Ra ≥	DIM			H mm	Ø mm	PCS		CBM m³		EAN 8009935	Code
- 1 -	3,5≈(35)	220-240	E14	120°	3000	350	80	NO	15.000	25.000	86	50	10	0,00272	ASN	007933	555345.0101	
- 1 -	6≈(60)	220-240	E27	120°	3000	600	80	NO	15.000	25.000	102	63	10	0,00430	ASN	007971	555346.0101	
- 2 -	5,5≈(50)	220-240	E27	120°	3000	550	80	NO	15.000	25.000	107	63	10	0,00430	ASN	007759	555343.0101	
- 2 -	5,5≈(50)	220-240	E27	120°	6000	550	80	NO	15.000	25.000	107	63	10	0,00430	ASN	007926	555344.0101	
- 3 -	5,8≈(60)	220-240	E27	30°	3000	260	80	SI	15.000	25.000	102	63	10	0,00430	BLT	010704	555028.0101	

Goccia - GLS glass E27



- 1 -



- 2 -



- 3 -



Astuccio con asola
Pack with slot

Vetro - Glass

Plastica - Plastic

Fig.	W	V			K	lm	Ra	DIM			H mm	Ø mm	PCS	CBM m ³	EAN 8009935	Code	
- 1 -	13≈(150)	220-240	E27	360°	3000	1300	80	SI	15.000	25.000	105	60	10	0,0071	ASA	102188	555284
- 1 -	13≈(150)	220-240	E27	360°	6500	1300	80	SI	15.000	25.000	105	60	10	0,0071	ASA	102256	555285
- 1 -	13≈(150)	220-240	E27	360°	4000	1300	80	SI	15.000	25.000	105	60	10	0,0071	ASA	102324	555370
- 2 -	6≈(60)	220-240	E27	360°	3000	600	80	NO	15.000	25.000	105	60	10	0,0071	ASA	007346	555276.0101
- 2 -	6,5≈(60)	220-240	E27	360°	4000	806	80	NO	15.000	25.000	106	60	10	0,0038	ASA	007353	555276.4K
- 2 -	8≈(60)	220-240	E27	360°	3000	800	80	SI	15.000	25.000	105	60	10	0,0071	ASA	101129	555286.0101
- 2 -	8≈(75)	220-240	E27	360°	4000	1055	80	NO	15.000	25.000	106	60	10	0,0038	ASA	101143	555286.4K
- 2 -	6,5≈(75)	220-240	E27	360°	3000	608	80	SI	15.000	25.000	105	60	10	0,0071	ASA	009289	555383.0101
- 3 -	8,5≈(60)	220-240	E27	230°	3000	850	80	NO	15.000	25.000	111	60	10	0,0071	ASA	020659	555215.0101
- 3 -	11≈(75)	220-240	E27	230°	3000	1055	80	NO	15.000	25.000	108	60	10	0,0040	ASA	020871	555218.3K
- 3 -	15≈(150)	220-240	E27	230°	3000	1500	80	NO	15.000	25.000	127	67	10	0,0095	ASA	101396	555306.0101
- 3 -	15≈(100)	220-240	E27	230°	4000	1521	80	NO	15.000	25.000	124	60	10	0,0045	ASA	101402	555306.4K
- 3 -	15≈(150)	220-240	E27	230°	6500	1500	80	NO	15.000	25.000	127	67	10	0,0095	ASA	101532	555307.0101
- 3 -	17,5≈(115)	220-240	E27	230°	3000	1800	80	NO	15.000	25.000	140	70	10	0,0069	ASA	101549	555307.3K
- 3 -	17,5≈(115)	220-240	E27	230°	4000	1800	80	NO	15.000	25.000	140	70	10	0,0069	ASA	101556	555307.4K

Goccia - GLS glass E27



- 1 -



- 2 -



- 3 -

Vetro - Glass

Fig.	W	V			K	lm	Ra \geq	DIM			H mm	\emptyset mm	PCS	CBM m ³		EAN 8009935	Code
- 1 -	8≈(60)	220-240	E27	-	3000	800	80	SI	15.000	25.000	105	60	10	0,0071	ASA	008435	555359.0101
- 2 -	10≈(75)	220-240	E27	360°	2200	1000	80	SI	15.000	25.000	105	60	10	0,0071	ASA	008503	555362.0101
- 3 -	4≈(40)	220-240	E27	360°	2200	400	80	NO	15.000	25.000	140	60	10	0,00816	ASA	008534	555363.0101

Crystal E14



- 1 -



- 2 -

Cristallo - Crystal

Fig.	W	V			K	lm	Ra \geq	DIM			H mm	\emptyset mm	PCS	CBM m ³		EAN 8009935	Code
- 1 -	3≈(25)	220-240	E14	360°	3000	300	80	NO	15.000	25.000	66	41	10	0,0035	ASN	020802	555235.0101
- 2 -	3≈(25)	220-240	E14	360°	3000	300	80	NO	15.000	25.000	80	31	10	0,0054	ASN	021496	555227.0101

Goccia speciale RGB Bluetooth Special standard RGB Bluetooth



- 1 -

Plastica - Plastic



Nuova serie di lampade LED RGB dimmerabili.....
Scarica l'App e crea i tuoi scenari anche a tempo di musica!
New series of dimmable RGB LED lamps.....
Download the App and create your own scenarios even at music time!



IOLight
Control unit
iOS 8.1+



Available on the
App Store

Fig.	W	V			Ra	DIM			H mm	Ø mm	PCS	CBM m³	EAN 8009935	Code
- 1 -	6	FULLCOLOR	220-240	E27	300°	80	SI	15.000	25.000	120	60	10	0,0071	ASA 004239 555322.0101

Dimmerabile direttamente da apparecchi iOS
Directly dimmable from iOS device

Lampade RGB controllate da i-Phone con le seguenti funzioni:

- Accende e spegne la lampada
- Controlla il livello di luminosità con la funzione dimmer lineare
- Cambia colore in automatico o mediante selezione
- Quando si ascolta musica può cambiare luminosità e colore a tempo con la musica
- Può controllare diverse sorgenti contemporaneamente (max 4 gruppi, ognuno max 4 lampade)

Applicazioni:

- Showroom, aree di ricevimento, bar, etc.
- Controllabili da apparecchi con app iOS 8.1+
- Distanza di copertura segnale: 20metr

RGB bulbs controlled by i.phone with the following functions:

- Turn the lights on and off
- Adjust brightness level with linear dimming functions
- Change color automatically or by selection
- When enjoy the audio could auto dimming and change color
- Could control several lighting devices at the same time (max 4 groups, each max 4 bulbs)

Applications:

- Showroom, reception areas, lounge, etc
- Smart devices with app iOS 8.1+
- Expected coverage: 20metres

G9



- 1 -



- 2 -



- 3 -

Plastica - Plastic



Astuccio normale
Normal Pack

Fig.	W	V			K	lm	Ra	DIM			H mm	Ø mm	PCS	CBM m³	EAN 8009935	Code
- 1 -	2~(25)	220-240	G9	250°	4000	200	80	NO	15.000	25.000	53	17	10	0,0058	ASN 102010 555293.0101	
- 2 -	3~(20)	220-240	G9	320°	3000	200	80	SI	15.000	25.000	48	16	10	0,0002	ASN 020888 555249.0101	

PAR 30 PAR 38



- 1 -

Plastica - Plastic



Astuccio normale
Normal Pack

PAR 30

Fig.	W	V			K	lm	Ra \geq	DIM			H mm	\emptyset mm	PCS		CBM m ³		EAN 8009935	Code
- 1 -	11,5≈(75)	220-240	E27	36°	4000	1150	80	NO	15.000	25.000	125	89	10		0,0300	ASN	102645	555302.0101

PAR 38

Fig.	W	V			K	lm	Ra \geq	DIM			H mm	\emptyset mm	PCS		CBM m ³		EAN 8009935	Code
- 1 -	14 ≈(75)	220-240	E27	75°	3000	1400	80	NO	15.000	25.000	140	120	10		0,0382	ASN	008558	555364.0101

GU10



- 1 -



- 2 -

Cod. RP0710
Emergenza per lampade
LED a 230V (Pag. 75)
Batteria da ordinare
separatamente (Cod. 00PB0800)
*Emergency for LED 230V LED lamps
(Page 75) Battery to be ordered
separately (Cod. 00PB0800)*



Fig.	W	V			K	lm	Ra \geq	DIM			H mm	\emptyset mm	PCS		CBM m ³		EAN 8009935	Code	Netto	QTY*
- 1 -	4≈(50)	220-240	GU10	45°	3000	400	80	SI	15.000	25.000	75	50	10		0,0027	ASN	020741	555248.0101	1,20	2.848
- 2 -	7≈(50)	220-240	GU10	36°	4000	700	80	NO	15.000	25.000	56	50	10		0,0027	ASN	102997	555304.0101		
- 2 -	6≈(40)	220-240	GU10	36°	3000	450	80	SI	15.000	25.000	56	50	10		0,0016	ASN	020932	555219.0101		

* Fino ad esaurimento - Offer valid while supplies last

MR16 - HL111

12V



MR16

Metallo - Metal

Fig.	W	V			K	lm	Ra ≥	DIM			H mm	Ø mm	PCS	CBM m³		EAN 8009935	Code
- 1 -	4≈(30)	12 AC/DC	GU5,3	36°	3000	400	80	NO	15.000	25.000	49	50	10	0,0027	ASN	128584	555064.0101
- 1 -	4≈(30)	12 AC/DC	GU5,3	36°	4000	400	80	NO	15.000	25.000	49	50	10	0,0027	ASN	004307	555065.0101

* Fino ad esaurimento - Offer valid while supplies last



Per lampade dimmerabili vedi Pag. 17
For dimmable lamps see Pag. 17

HL111

Fig.	W	V			K	lm	Ra ≥	DIM			H mm	Ø mm	PCS	CBM m³		EAN 8009935	Code
- 4 -	10≈(60)	12 AC/DC	G53	36°	4000	1000	80	NO	15.000	25.000	62	111	10	0,0165	ASN	008688	555367.0101

G4

12V



Plastica - Plastic



Fig.	W	V			K	lm	Ra ≥	DIM			H mm	Ø mm	PCS	CBM m³		EAN 8009935	Code	Netto	QTY*
- 1 -	2,5≈(20)	12DC/AC	G4	250°	3000	250	80	NO	15.000	25.000	45	17	10	0,0058	ASN	102225	555296.0101		
- 1 -	2,5≈(25)	12DC/AC	G4	250°	4000	250	80	NO	15.000	25.000	45	17	10	0,0058	ASN	102294	555297.0101		
- 2 -	2,5≈(25)	12DC/AC	G4	250°	3000	230	80	NO	15.000	25.000	36	22	10	0,0058	ASN	102362	555298.0101	1,00	1.180
- 2 -	2,5≈(25)	12DC/AC	G4	250°	4000	230	80	NO	15.000	25.000	36	22	10	0,0058	ASN	102430	555299.0101	1,00	910

* Fino ad esaurimento - Offer valid while supplies last

MICRO LED TRAF0
Cod. RN9140

Trasformatore elettronico indipendente dimmerabile, per lampade alogene (20÷105W) e lampade a LED (3÷55W), 12Vac (* max 3 lampade)
Dimmable independent electronic transformer halogen lamps (20÷105W) and LED lamps (3÷55W), 12Vac (* max 3 lamps)

LPH	Vac IN		Carico Load	W	Hz	ta °C	tc °C	Vout Vac
120x39x28	220-240	C	HALO LED *	20÷105 3÷55	50/60	-15...50	80	12



Cod. RP0711
Emergenza per lampade LED a 12V (Pag. 75)
Batteria da ordinare separatamente (Cod. 00PB0800)
Emergency for LED 12V LED lamps (Page 75)
Battery to be ordered separately (Cod. 00PB0800)



GX53



- 1 -

Plastica - Plastic

NEW

Fig.	W	V			K	lm	Ra ≥	DIM			H mm	Ø mm	PCS		CBM m³		EAN 8009935	Code
- 1 -	4≈(7)	220-240	GX53	180°	3000	320	80	NO	15.000	25.000	24	75	1	-	ASN	189417	6011249	
- 1 -	4≈(7)	220-240	GX53	180°	4000	320	80	NO	15.000	25.000	24	75	1	-	ASN	211668	6011256	
- 1 -	9≈(15)	220-240	GX53	180°	3000	720	80	NO	15.000	25.000	25	75	1	-	ASN	223746	6014653	
- 1 -	9≈(15)	220-240	GX53	180°	4000	720	80	NO	15.000	25.000	25	75	1	-	ASN	314666	6014660	
- 1 -	9≈(15)	220-240	GX53	180°	3000	720	80	SI	15.000	25.000	25	75	1	-	ASN	513809	6014653.DIM	
- 1 -	9≈(15)	220-240	GX53	180°	4000	720	80	SI	15.000	25.000	25	75	1	-	ASN	544513	6014660.DIM	

Comparazione sulle equivalenti fluorescenti integrate - Comparison on equivalent fluorescent integrated

PAR56

IP68



- 1 -



Esempio applicativo - Application example

Plastica - Plastic

Fig.	W	V	mA			K	lm	Ra ≥	DIM			H mm	Ø mm	PCS		CBM m³		EAN 8032793	Code
- 1 -	27	12Vdc	-	cavo	160°	3000	1350	80	NO	15.000	25.000	100	183	10	0,0044	ASN	858713	24169	
- 1 -	27	27Vdc	350	cavo	160°	FULLCOLOR	-	-	NO	15.000	25.000	100	183	12	0,0044	ASN	851912	24162	

MONOCROMATICO: cavo in uscita in silicone a 2 conduttori. Lunghezza 1m - **MONOCHROMATIC:** 2-conductor silicone output cable. Length 1m.

RGB: cavo in uscita in silicone a 4 conduttori. Lunghezza 1m - **RGB:** 4-conductor silicone output cable. Length 1m.

R7s



- 1 -



- 2 -

Plastica - Plastic

Fig.	W	V			K	lm	Ra ≥	DIM			H mm	Ø mm	PCS		CBM m³		EAN 8009935	Code
- 1 -	12≈(120)	85-265	R7s	360°	3000	1200	83	NO	15.000	30.000	135	22	1	0,0003	ASA	102652	555315.0101	
- 2 -	5≈(50)	85-265	R7s	360°	3000	500	83	SI	15.000	30.000	78	22	1	0,0001	ASA	102720	555316.0101	
- 2 -	10≈(100)	85-265	R7s	360°	3000	1000	83	SI	15.000	30.000	118	22	1	0,0002	ASA	102508	555300.0101	

Globo - Globe lamp



- 1 -



- 2 -



- 3 -



- 4 -

Vetro - Glass

Plastica - Plastic

Vetro - Glass

Fig.	W	V			K	lm	Ra ≥	DIM			H mm	Ø mm	PCS	CBM m ³		EAN 8009935	Code
- 1 -	10≈(75)	220-240	E27	360°	3000	1000	80	SI	15.000	25.000	128	95	4	0,0153	ASA	102393	555209
- 1 -	10≈(75)	220-240	E27	360°	3000	1000	80	SI	15.000	25.000	175	125	4	0,0153	ASA	102461	555210
- 2 -	5≈(40)	220-240	E27	360°	3000	500	80	NO	15.000	25.000	128	95	4	0,0153	ASA	007230	555338.0101
- 2 -	5≈(40)	220-240	E27	360°	3000	500	80	SI	15.000	25.000	128	95	4	0,0153	ASA	007469	555339.0101
- 2 -	5≈(40)	220-240	E27	360°	3000	500	80	SI	15.000	25.000	175	125	4	0,0153	ASA	007162	555337.0101
- 2 -	10≈(75)	220-240	E27	360°	3000	1000	80	NO	15.000	25.000	175	125	4	0,0153	ASA	008695	555368.0101
- 2 -	10≈(75)	220-240	E27	360°	3000	1000	80	SI	15.000	25.000	175	125	4	0,0153	ASA	008718	555369.0101
- 3 -	9≈(60)	220-240	E27	300°	3000	900	80	NO	15.000	25.000	133	95	4	0,0175	ASA	020239	555209.0101
- 3 -	10≈(60)	220-240	E27	300°	3000	1000	80	SI	15.000	25.000	162	125	4	0,0183	ASA	020307	555210.0101
- 3 -	13≈(100)	220-240	E27	300°	3000	1300	80	NO	15.000	25.000	133	95	4	0,0175	ASA	020161	555208.0101
- 3 -	15≈(100)	220-240	E27	300°	3000	1500	80	SI	15.000	25.000	162	125	4	0,0183	ASA	020093	555207.0101
- 4 -	4≈(30)	220-240	E27	300°	2100	320	80	SI	15.000	15.000	190	150	6	-	ASA	508600	558108.0101
- 1 -	10≈(75)	220-240	E27	360°	4000	1000	80	SI	15.000	25.000	128	95	4	0,0153	ASA	8032979 492519	555371
- 1 -	10≈(75)	220-240	E27	360°	4000	1000	80	SI	15.000	25.000	175	125	4	0,0153	ASA	8032979 492601	555339



- 1 -

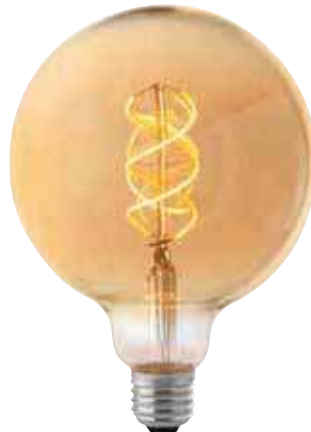

- 2 -

Vetro - Glass



- 3 -



- 4 -



- 5 -



- 6 -

Vetro - Glass

Fig.	W	V			K	lm	Ra	DIM			H mm	Ø mm	PCS		CBM m ³		EAN 8009935	Code
- 1 -	5≈(40)	220-240	E27	360°	2200	-	80	SI	15.000	25.000	175	125	4		0,0153	ASN	008084	555349.0101
- 2 -	5≈(30)	220-240	E27	360°	2200	-	80	SI	15.000	25.000	140	95	5		0,0088	ASN	617253	557217.0101
- 2 -	5≈(30)	220-240	E27	360°	2200	-	80	SI	15.000	25.000	175	125	4		0,0153	ASN	610643	557216.0101
- 3 -	5≈(40)	220-240	E27	300°	3000	-	80	SI	15.000	25.000	140	95	4		0,0153	ASN	009043	555374.0101
- 3 -	5≈(40)	220-240	E27	300°	3000	-	80	SI	15.000	25.000	175	125	4		0,0153	ASN	009203	555377.0101
- 4 -	5≈(40)	220-240	E27	300°	3000	-	80	SI	15.000	25.000	140	95	4		0,0153	ASN	008892	555373.0101
- 4 -	5≈(40)	220-240	E27	300°	3000	-	80	SI	15.000	25.000	175	125	4		0,0153	ASN	009111	555376.0101
- 5 -	5≈(40)	220-240	E27	300°	3000	-	80	SI	15.000	25.000	140	95	4		0,0153	ASN	008053	555348.0101
- 5 -	5≈(40)	220-240	E27	300°	3000	-	80	SI	15.000	25.000	175	125	4		0,0153	ASN	009050	555375.0101
- 6 -	5≈(30)	220-240	E27	300°	2700	330	80	SI	15.000	15.000	135	95	50		0,0153	ASN	012241	558109.0101
- 6 -	5≈(30)	220-240	E27	300°	2700	330	80	SI	15.000	15.000	175	125	20		0,0153	ASN	012265	558110.0101



Big size decò - fumè

Classic Deco



- 1 -



- 2 -

Vetro - Glass

Fig.	W	V			K	lm	Ra \geq	DIM			H mm	\emptyset mm	PCS		EAN 8009935	Code
- 1 -	6≈(50)	220-240	E27	300°	2100	120	80	SI	10.000	15.000	410	195	4	ASN	378325	4300391
- 2 -	4≈(40)	220-240	E27	300°	2100	100	80	SI	10.000	15.000	275	165	4	ASN	165082	4300081



- 3 -



- 4 -

Vetro - Glass

Fig.	W	V			K	lm	Ra \geq	DIM			H mm	\emptyset mm	PCS		EAN 8009935	Code
- 3 -	4≈(40)	220-240	E27	300°	2100	100	80	SI	10.000	15.000	270	170	4	ASN	112615	4300301
- 4 -	6≈(50)	220-240	E27	300°	2100	120	80	SI	10.000	15.000	290	160	4	ASN	703236	4300061

LAMPADINE INCANDESCENTI - INCANDESCENT LAMPS
Solo per mercato extra CEE - Only for Extra CEE market

Goccia - Standard							
	W	V				PCS	EAN 8009935 Code
	40	230	CH	E27	SI	100	- 017429.0101
	60	230	CH	E27	SI	100	029638 017427.0101
	75	230	CH	E27	SI	100	029645 017425.0101
	100	230	CH	E27	SI	100	029652 017423.0101
	200	230	CH	E27	SI	50	029881 017420.0101
	60	24÷25	CH	E27	SI	100	007889 000998.0101

Goccia semafori - Standard traffic signal							
	W	V				PCS	EAN 8009935 Code
	70	220÷240	CH	E27	SI	100	028570 088615.0101

Sfera - Ball lamp							
	W	V				PCS	EAN 8009935 Code
	25	230	CH	E27	SI	100	031518 038970.0101
	40	230	CH	E14	SI	100	031389 039690.0101
	40	230	CH	E27	SI	100	031525 039720.0101
	60	230	CH	E14	SI	100	031396 037980.0101

Oliva - Candle							
	W	V				PCS	EAN 8009935 Code
	25	230	CH	E14	SI	100	033758 044816.0101
	40	230	CH	E14	SI	100	033765 044813.0101
	60	230	CH	E14	SI	100	033772 044815.0101

Piccola Pera - Pigmy lamp							
	W	V				PCS	EAN 8009935 Code
	1/2c/10	230	CH	E14	SI	100	013705 054571.0101
	15	230	CH	E14	SI	100	013729 053408.0101
	25	230	CH	E14	SI	100	013736 053414.0101

Piccola Pera per Frigoriferi - Fridge Pigmy lamp							
	W	V				PCS	EAN 8009935 Code
	15	240	CH	E14	SI	100	013798 052960.0101

Piccola Pera per Forni 300° - Oven Pigmy lamp 300°							
	W	V				PCS	EAN 8009935 Code
	15	240	CH	E14	SI	100	013750 052962.0101
	15	240	CH	E14	SI	12	092295.0112 (BLISTER)
	25	240	CH	E14	SI	100	014047 052721.0101

LAMPADINE HALOGENE - HALOGEN LAMPS
Solo per mercato extra CEE - Only for Extra CEE market

Sfera - Ball lamp									
	W	V			K	PCS	Code	QTY	Euro Cad
	28	230	CH	E27	2900	100	444050.0101	3.525	0,50

Globo - Globe lamp									
	W	V			K	PCS	Code	QTY	Euro Cad
	28	230	CH	E27	-	12	444054.0101	393	0,50
	42	230	CH	E27	-	12	444055.0101	100	0,50
	70	230	CH	E27	-	12	444056.0101	2.836	0,50

GY6,35									
	W	V			K	PCS	Code	QTY	Euro Cad
	40	12	CH	GY6,35	-	50	444020.0101	3.510	0,50

MR16									
	W	V			K	PCS	Code	QTY	Euro Cad
	16	12	-	GU5.3	4.000	50	444023.0112	1.822	0,50

Lineare - Linear lamp									
	W	V			K	PCS	Code	QTY	Euro Cad
	160	230	CH	R7s-15	3.000	12	444046.0112	13.492	0,50

Reflector R80									
	W	V			K	PCS	Code	QTY	Euro Cad
	42	230	CH	E27	-	12x1	444011.0112	9.469	0,50

Tubolare - Tubular lamp									
	W	V			K	PCS	Code	QTY	Euro Cad
	28	230	CH	E14	-	20	444077.0101	5.680	0,50

TOT: 40.827