

Binari trifase PLUS - *Threephase tracks PLUS*

Binari trifase PLUS
Threephase tracks PLUS

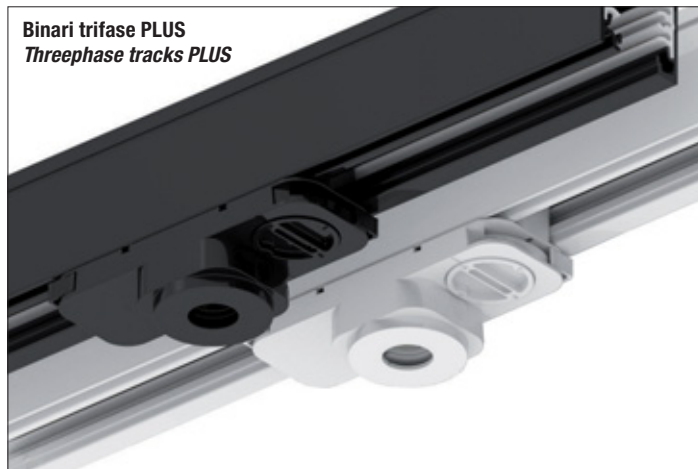

Binario trifase ad incasso a scomparsa
(a richiesta con sovrapprezzo del 20% dal listino).

*Hidden in-built threephase track
(on request with a 20% surcharge
from the price list).*



Binari trifase PLUS - *Threephase tracks PLUS*

Colour	A	mm	pcs	Kg	Code	Euro
B	16	1000	001	1,10	9000-1/W-ST	34,90
N	16	1000	001	1,10	9000-1/B-ST	34,90
B	16	2000	001	2,10	9000-2/W-ST	71,40
N	16	2000	001	2,10	9000-2/B-ST	71,40
B	16	3000	001	3,40	9000-3/W-ST	106,05
N	16	3000	001	3,40	9000-3/B-ST	106,05
B	16	4000	001	4,50	9000-4/W-ST	135,90
N	16	4000	001	4,50	9000-4/B-ST	135,90

Adattatore meccanico a 4 conduttori *Electro-Mechanical 4 conductor adapter*

Colour	A	pcs	Kg	Code	Euro
B	max 10Kg	010	0,05	90009-4/W	14,39
B	Nippel per sospensione			S-9009/BC-W	7,41

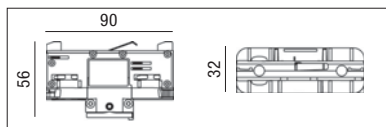

Giunto lineare *Linear Joint*

Colour	A	pcs	Kg	Code	Euro
B	16	010	0,05	9003/W	9,62
N	16	010	0,05	9003/B	9,62

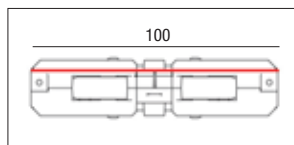

UN UNICO BINARIO PER TUTTE LE TUE IDEE DI LUCE

I nuovi binari Relco sono **TRIFASE PLUS**, incorporano cioè in un unico prodotto le funzionalità delle tre tipologie di binari EUROSTANDARD presenti sul mercato e sono quindi una soluzione **economicamente vantaggiosa** e con un grande valore aggiunto. Questi binari sono infatti l'investimento giusto per ogni tipo di progetto perché garantiscono la **compatibilità** con tutti i sistemi ad oggi sul mercato e lasciano la libertà di scegliere in un secondo momento la tipologia di sistema di illuminazione da adottare, dando quindi la **massima flessibilità progettuale presente e futura**. I binari TRIFASE PLUS® di Relco sono approvati FELV, prodotti in alluminio estruso con contatti in rame e parti plastiche in PVC. Sono disponibili in versione standard o da controsoffitto in due diverse colorazioni: Bianco e Nero.

A richiesta: binario ad incasso a scomparsa

JUST ONE TRACK FOR ALL YOUR LIGHTING IDEAS

New Relco track system is **THREEPHASE TRACK PLUS**, it combines the functionalities of the three EUROSTANDARD tracks currently available in the market in one unique product and is therefore a **convenient solution** with a **great added value**. In fact this system is the right investment for all the kinds of projects because it guarantees **compatibility** with all the existing systems. At the same time mounting this system allows the end user to select the type of luminaire at any phase of the project, thus bringing present and future **flexibility in lighting projects**.

Relco **THREEPHASE TRACK PLUS** track system is FELV tested and approved. It is manufactured in extruded aluminium with copper contacts and pvc plastic parts. It is available in two colours: White and Black, both in standard and recessed versions.

On request: hidden in-built track

440V 50Hz **IP20**

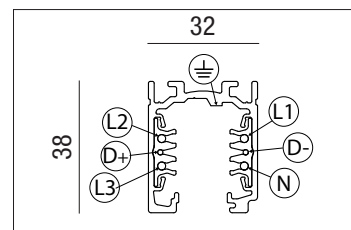

Tappo di chiusura - *End cap*

Colour	pcs	Kg	Code	Euro
B	010	0,08	9004/W	1,35
N	010	0,08	9004/B	1,35



Adattatore meccanico *Mechanical adapter*

Colour	pcs	Kg	Code	Euro	
B	max 15Kg	010	0,02	S-9000/M-W	7,41
N	max 15Kg	010	0,02	S-9000/M-B	7,41

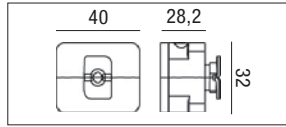

Giunto diretto *Middle feed*

Colour	A	pcs	Kg	Code	Euro
B	16	010	0,20	9010/W	28,88
N	16	010	0,20	9010/B	28,88

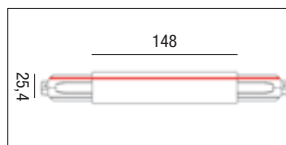

Giunto X - X Joint

Colour	A	pcs	Kg	Code	Euro
B	16	010	0,38	9017/W	63,00
N	16	010	0,38	9017/B	63,00

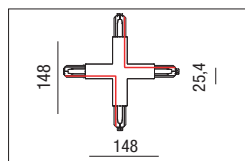

Giunto L - L Joint

Colour	A	pcs	Kg	INT. Euro	EXT. Euro
B	16	010	0,20	9011/W 30,00	9012/W 30,00
N	16	010	0,20	9011/B 30,00	9012/B 30,00

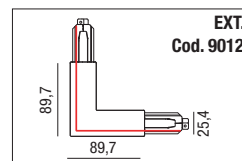
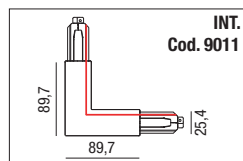

Giunto T - T Joint

Colour	A	pcs	Kg	INT. DX *	Euro	INT. SX *	Euro
B	16	010	0,29	9016/W	46,00	9015/W	46,00
N	16	010	0,29	9016/B	46,00	9015/B	46,00

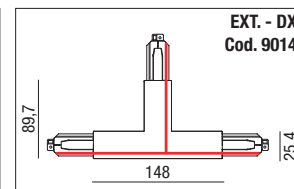
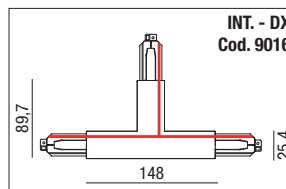

Colour	A	pcs	Kg	EXT. DX *	Euro	EXT. SX *	Euro
B	16	010	0,29	9014/W	46,00	9013/W	46,00
N	16	010	0,29	9014/B	46,00	9013/B	46,00

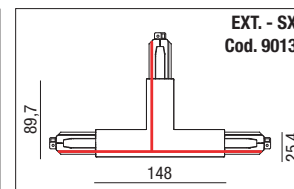
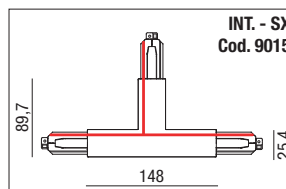

Importante: per il collegamento degli altri componenti tenere le polarità nella stessa posizione. La dicitura interno/esterno sta ad indicare la posizione del cavo negativo del DALI rispetto al componente.

Important: to connect all the other components, the polarity must be kept in the same position. The lettering Internal/External refers to the position of the negative connector for the DALI respectively to the components

N.B: Nel giunto interno il cavo DalI negativo passa all'interno.

N.B: In the internal joint, the negative DALI cable goes from within.

N.B: Nel giunto esterno il cavo DalI negativo passa all'esterno.

N.B: In the external joint, the negative DALI cable goes from the outside.

Giunto flessibile - Adjustable corner

Colour	A	pcs	Kg	Code	Euro
B	16	010	0,24	9018/W	36,00
N	16	010	0,24	9018/B	36,00

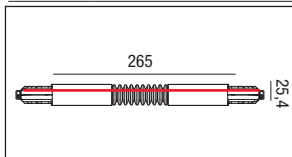

Testata - Live end

Colour	A	pcs	Kg	DX *	Euro	SX *	Euro
B	16	010	0,10	9001/W	13,70	9002/W	13,70
N	16	010	0,10	9001/B	13,70	9002/B	13,70

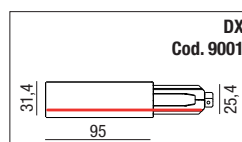
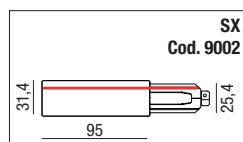

Esempio di composizione - Example of composition

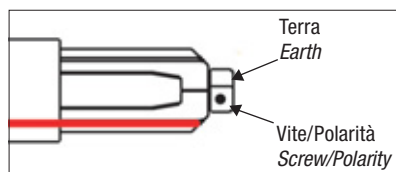

* I riferimenti SX e DX sono dati in base alla posizione della testa della vite sulla polarità.
SX and SX references are given having as a base the head of the screw on the polarity.

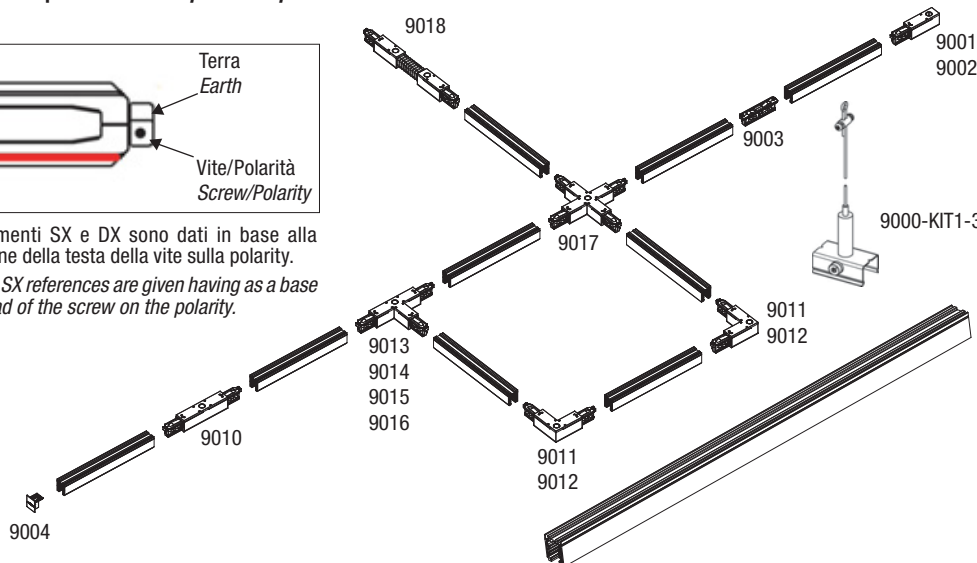

Kit per fissaggio a sospensione Suspension kit

Cod. 9000-KIT1-3
Euro: 29,00

Kit per fissaggio a sospensione composto da:
- Tenditore a vite
- Filo in acciaio Ø 1,5mm
- Lunghezza 3m
- Clip con tenditore automatico

Complete suspension Kit composed by:
- Screw gripper
- Steel cable Ø 1,5mm
- Length 3m
- Clamp with automatic gripper